

Exhibit B
RFx 300023702 T-Number DEQ09

UNDERGROUND STORAGE TANK CLOSURE/CHANGE-IN-SERVICE GUIDANCE DOCUMENT

LOUISIANA DEPARTMENT OF ENVIRONMENTAL QUALITY
UNDERGROUND STORAGE TANK DIVISION
P. O. BOX 4313
BATON ROUGE, LOUISIANA 70821-4313



EFFECTIVE DATE – May 1, 2010

TABLE OF CONTENTS

Section 1 – General Information

| | |
|---|---|
| 1.1 Introduction | 1 |
| 1.2 Definitions | 1 |
| 1.3 Other Agency Jurisdiction and Notifications | 2 |
| 1.4 Use of LDEQ Certified Workers | 2 |
| 1.5 Closure Process Flowchart | 2 |

Section 2 – Reporting Requirements

| | |
|---|---|
| 2.1 Registration | 4 |
| 2.2 30-Day Notification Prior to Closure or Change-in-Service | 4 |
| 2.3 7-Day Notification Prior to Closure or Change-in-Service | 4 |
| 2.4 UST Closure Assessment Form and Report | 5 |
| 2.5 Reporting Evidence of a Release | 7 |

Section 3 – General Closure Guidelines

| | |
|-------------------------------------|----|
| 3.1 General Information | 8 |
| 3.2 Accredited Laboratories | 8 |
| 3.3 Ozone Action Days | 8 |
| 3.4 Recommended Safety Practices | 8 |
| 3.5 UST System Removal and Labeling | 12 |
| 3.6 UST Disposal and UST Re-use | 13 |
| 3.7 Closing UST Systems in Place | 14 |
| 3.8 Sample Collection Procedures | 14 |

Section 4 – Closure Sample Locations

| | |
|---|----|
| 4.1 General Requirements | 16 |
| 4.2 Closure Samples Collected During Excavation and Removal | 17 |
| 4.3 Closure Samples Collected From Soil Borings | 22 |

Section 5 – Sample Location Deviations

| | |
|---|----|
| 5.1 General Requirements | 28 |
| 5.2 Excavating Contamination During UST System Closures | 28 |
| 5.3 Previously Contaminated UST Sites or Sites Currently Undergoing Remediation | 28 |
| 5.4 UST Sites Contaminated With Free-Phase Product | 29 |

Section 6 – Temporary Closure Assessment Requirements

| | |
|------------------------------------|----|
| 6.1 Temporary Closure Requirements | 30 |
|------------------------------------|----|

Section 7 – Sample Analyses

31

Section 8 – Sample Results Interpretation

| | |
|---|----|
| 8.1 General Information | 32 |
| 8.2 Synthetic Precipitation Leaching Procedure (SPLP) | 32 |
| 8.3 Total Petroleum Hydrocarbon (TPH) Fraction Analysis | 34 |
| 8.4 Conveyance Notice Filing | 36 |

| | |
|--|----|
| 8.5 Enclosed Structure Evaluation | 38 |
| Section 9 – Contaminated Soil Re-use or Disposal | |
| 9.1 General Information | 38 |
| 9.2 Contaminated Soil Re-Use | 38 |
| 9.3 Contaminated Soil Disposal | 38 |
| Section 10 – Contaminated Water Discharge or Disposal | |
| 10.1 General Information | 39 |
| 10.2 Water Discharge Permit | 39 |
| 10.3 Contaminated Water Disposal | 39 |
| Section 11 – Record Keeping | 39 |
| | |
| Appendices | |
| Appendix A – Recommended Industry Codes and Standards for Underground Storage Tank Closure or Change-in-Service | 40 |
| Appendix B – Underground Storage Tank Division Regional Office Contact Information and Map Showing Parishes Covered by Regional Offices | 41 |
| Appendix C – Notification of Intent to Perform a Closure or Change-in- Service to an Underground Storage Tank System Form | 43 |
| Appendix D – Seven Day Notification – Fax Transmittal Form | 44 |
| Appendix E – Underground Storage Tank Closure/Assessment Form | 45 |
| Appendix F – Sample Site Drawing | 46 |
| Appendix G – Site Drawing Form | 47 |
| Appendix H – Sample Chain-of-Custody Record | 48 |
| Appendix I – Conveyance Notification Form Letter | 49 |
| Appendix J – UST Closure Checklist | 50 |
| Appendix K – Sample Laboratory Analytical Results Table | 52 |
| Appendix L – List of Industrial Solid Waste Facilities | 54 |
| Appendix M – UST Soil Screening Standards | 55 |

SECTION 1 – GENERAL INFORMATION

1.1 Introduction

The purpose of this document is to provide guidance for conducting a petroleum Underground Storage Tank (UST) system closure or change-in-service that meets the requirements of Chapter 9 of the Louisiana Underground Storage Tank regulations (LAC 33:XI). This document is intended to be used in conjunction with the UST regulations and industry codes and standards. Appendix A contains a list of industry codes and standards that pertain to UST closures and changes-in-service.

This document does not specifically address the analytical requirements of closing USTs that contained hazardous substances. Closing hazardous substance UST systems will be addressed on a case-by-case basis. **Owners of hazardous substance USTs should contact the appropriate UST Division Regional Office for guidance prior to beginning any closure work.**

UST regulations require that owners and operators measure for the presence of a release, where contamination is most likely to be present at a UST site, before permanent closure or change-in-service is completed. When assessing a UST site for the presence of contamination, following proper sampling procedures is crucial. An environmental site assessment plays an important role in demonstrating that a site does not pose a threat to human health or the environment. The Louisiana Department of Environmental Quality (LDEQ) has prepared this document to explain the site assessment requirements for UST closures and changes-in-service.

Questions regarding this document should be directed to the UST Division Regional Office responsible for the parish in which the UST is located. Appendix B contains the telephone numbers, addresses and parishes covered by each UST Division Regional Office. UST Division staff member contact information may also be found on the LDEQ website at <http://www.deq.louisiana.gov> (Note: go to DIVISIONS » Underground Storage Tank and Remediation Division » Underground Storage Tank » UST Contact Information).

1.2 Definitions

The following definitions are provided for clarification purposes:

Permanent Closure – the process of removing and disposing of a UST system no longer in service, including the process of abandoning such a system in place through the use of prescribed techniques for the purging of vapors and the filling of the vessel with a solid, inert material; the process of properly labeling a tank; and the process of collecting subsurface samples.

Change-in-Service – to change the contents of a UST from a regulated substance (e.g., gasoline, diesel, etc.) to a non-regulated substance (e.g., cottonseed oil, etc.). Before a change-in-service is completed, the UST system must be emptied and cleaned by removing all liquids and accumulated sludge, and a site assessment must be conducted in accordance with LAC 33:XI.907 and this Guidance Document.

Temporary Closure – the temporary removal from service of a UST.

Petroleum – crude oil or any fraction thereof that is liquid at standard conditions of temperature and pressure (60° Fahrenheit and 14.7 pounds per square inch absolute), including, but not limited to, motor fuels, jet fuels, distillate fuel oil, residual fuel oils, lubricants, petroleum solvents, used oils, ethanol blends, and biodiesel blends.

1.3 Other Agency Jurisdiction and Notifications

Local Fire Departments and/or Local Fire Prevention Bureaus must be contacted prior to performing closure of USTs. City or local demolition permits may also be required. Some local Fire Prevention Bureaus do not allow USTs to be closed in place. Coordination should be made with local authorities prior to closing tanks in place.

Louisiana One Call (811 or 1-800-272-3020) must be notified at least 48 hours prior to conducting any excavation, soil borings, or ground-breaking activities. Consult www.laonecall.com for more information.

1.4 Use of LDEQ Certified Workers

Only LDEQ Closure Certified Workers may supervise a UST closure or change-in-service. LAC 33:XI.905.A.2 requires UST owners to ensure that the individual that exercises supervisory control over all closure-critical junctures is certified in accordance with LAC 33:XI.Chapter 13. The certified individual must be present at the site and must exercise responsible supervisory control during all closure-critical junctures of the closure process. LAC 33:XI.1303 defines closure-critical junctures as the process of cleaning/vapor removal, all subsurface sample collection events, and the process of removal of the tank or filling the tank with inert material. A list of LDEQ certified workers may be obtained from the UST Division – UST at (225) 219-3678 or from the LDEQ website at <http://www.deq.louisiana.gov> (DIVISIONS » Underground Storage Tank and Remediation Division » Underground Storage Tank click quick link Registrations and Permits. Under Certified Worker Information there is a link to the current list of certified workers).

1.5 Closure Process Flowchart

The flowchart on the following page is a graphical representation of the UST closure or change-in-service process. It is presented to UST owners and persons performing UST closures or changes-in-service as an aid in understanding the

closure process and the LDEQ requirements. Referral to the flowchart can assist UST owners and contractors in determining where they are in the process.

CLOSURE/CHANGE-IN-SERVICE PROCESS FLOWCHART

What happens when a UST is closed or a UST change-in-service is performed?

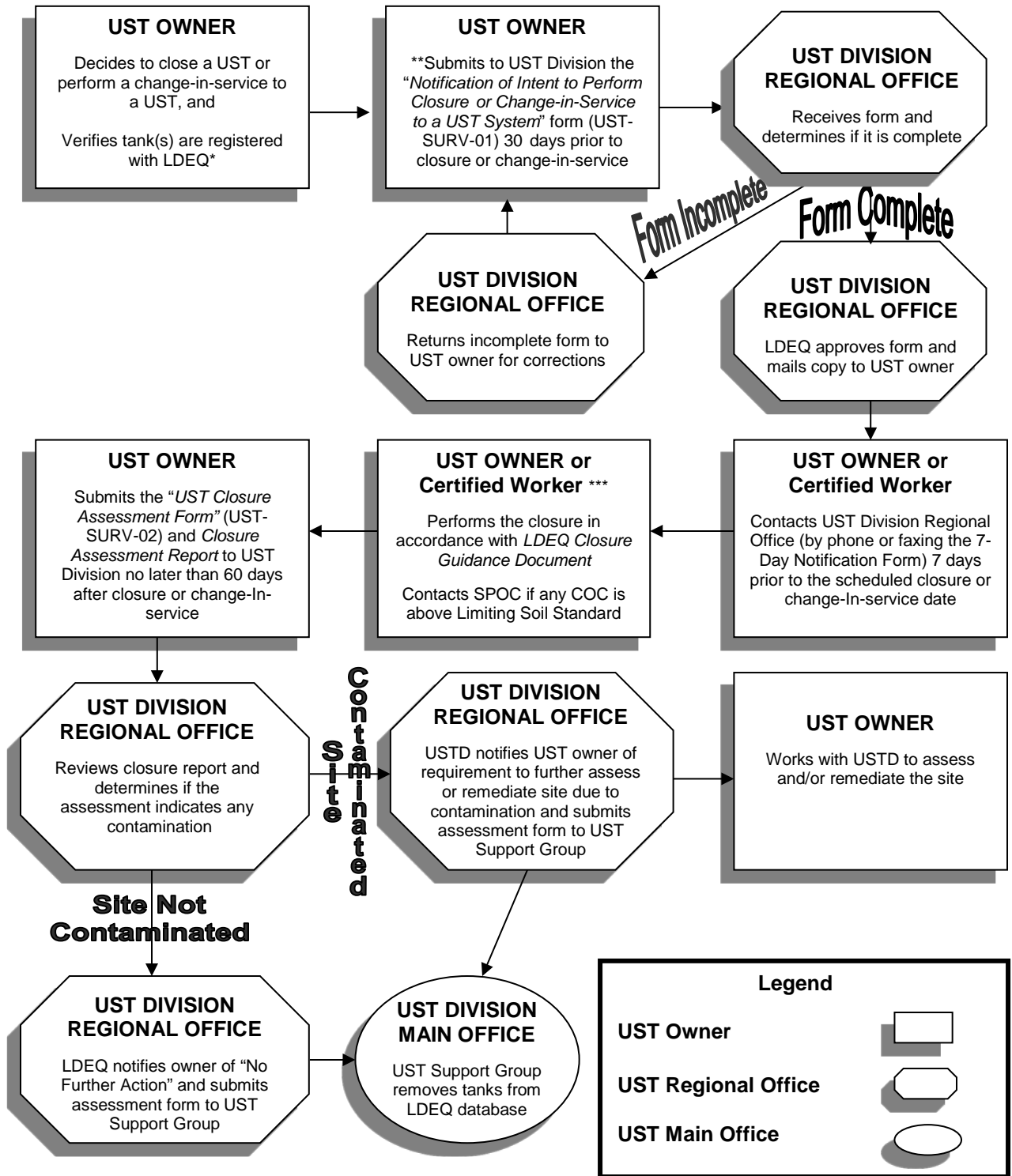

* If the tanks are not registered, the UST owner must submit an "Underground Storage Tanks Registration" form (UST-REG-01) to LDEQ – UST Support Group.

** The 30-day period can be waived by UST Division Regional Office staff, allowing closures or changes-in-service sooner if extenuating circumstances exist.

*** If closure/change-in-service does not begin within 90 days after LDEQ approval, the UST-SURV-01 form must be re-submitted.

SECTION 2 – REPORTING REQUIREMENTS

2.1 Registration

Prior to performing a UST closure or change-in-service, the UST owner must verify that the UST system has been registered with LDEQ. Tank registration information can be verified by contacting the LDEQ UST at (225) 219-3702 or the appropriate UST Division Regional Office. Please be prepared to provide the facility's name and address, UST owner's name, and the LDEQ Agency Interest number if known at the time of the call. If the "Underground Storage Tank Registration" form (UST-REG-01) has not been filed, then the UST owner must submit the form and associated registration fees to the address provided on the most recent form. The UST-REG-01 form can be found on the LDEQ website at <http://www.deq.louisiana.gov> (DIVISIONS » Underground Storage Tank and Remediation Division » Underground Storage Tank Quick Link to UST Forms).

2.2 30-Day Notification Prior to Closure or Change-in-Service

LAC 33:XI.905.A specifies that the UST owner must submit the "Notification of Intent to Perform a Closure or Change-In-Service to an Underground Storage Tank System" form (UST-SURV-01). The UST-SURV-01 form must be submitted to the appropriate UST Division Regional Office for processing. UST Division Regional Office addresses and contact information can be found on the LDEQ website at <http://www.deq.louisiana.gov> (DIVISIONS » Underground Storage Tank and Remediation Division » Underground Storage Tank » UST Contact Information). The UST Division Regional Office will approve or reject the form and return a copy to the UST owner. **Forms that do not contain the signature of the owner, name of the contractor, or the name of the laboratory chosen to analyze the samples will be rejected.** Closure or change-in-service may proceed 30 days after the date of approval. This 30-day period can be waived by UST Division Regional Office staff, allowing closures or changes-in-service sooner if extenuating circumstances exist (expedited tank closure necessary due to contamination, tank found during a construction project, etc.). The submitted form becomes invalid if the closure or change-in-service is not initiated within 90 days after approval. A new form must be submitted if the owner/operator intends to perform the UST closure or change-in-service 90 days after approval.

The UST-SURV-01 Form can be obtained from the UST Division, any UST Division Regional Office, or the LDEQ website at <http://www.deq.louisiana.gov> (DIVISIONS » Underground Storage Tank and Remediation Division » Underground Storage Tank Quick Link to UST Forms).

2.3 7-Day Notification Prior to Closure or Change-in-Service

LAC 33:XI.905.A.1.b specifies that the UST owner must notify the appropriate UST Division Regional Office by fax, email, or telephone 7 days prior to the scheduled date of the UST closure or change-in-service. A representative designated by the UST owner or the certified closure contractor may make the

notification for the owner. In the event that all regional personnel are in the field at the time the telephone call is made, the Regional Office will accept a mailed or faxed notice provided on a completed UST-ENF-05 form (Appendix D). Failure to notify the UST Division Regional Office at least 7 days prior to implementing the closure is a violation of LAC 33:XI.905.A.1.b. UST Division regional inspectors may monitor closure-critical juncture activities at the site during closures and changes-in-service.

2.4 UST Closure Assessment Form and Report

2.4.1 General

LAC 33:XI.907.A specifies that the UST owner must submit the results of the closure assessment to LDEQ within 60 days following permanent closure or change-in-service. A completed Underground Storage Tank Closure/Assessment Form (UST-SURV-02) and a Closure Assessment Report that follows the format described on the following pages in the level of detail indicated must be submitted as the closure assessment results. Consistency in reporting will expedite LDEQ's review and response to the UST owner. **Two separate copies of the Closure Assessment Report must be submitted in a format no larger than 8 ½"x14"**.

The UST-SURV-02 form and Closure Assessment Report must be submitted to the appropriate UST Division Regional Office for processing. The UST Division Regional Office will approve or reject the form and report and will return a signed copy of the UST-SURV-02 form to the UST owner. UST-SURV-02 forms and Closure Assessment Reports that do not contain all of the required information will be rejected and returned to the UST owner for corrections or completion.

2.4.2 Underground Storage Tank Closure/Assessment Form

The UST Closure Assessment Form (UST-SURV-02) (Appendix E) must be filled out completely. If any sections do not apply, enter "N/A" and a brief explanation should be included. **The UST owner and the certified UST worker that supervised the closure or change-in-service activities must sign the form.**

The UST-SURV-02 Form can be obtained from the UST Division, any UST Division Regional Office, or the LDEQ website at <http://www.deq.louisiana.gov> (DIVISIONS » Underground Storage Tank and Remediation Division » Underground Storage Tank Quick Link to UST Forms).

2.4.3 Site Drawing



A site drawing, using the symbols identified below and **drawn to scale**, must include the following information:

1. General site layout
2. Tank locations, sizes, and the substance(s) stored
3. Dispenser locations

4. Depth to groundwater (if encountered)
5. Dimensions of the excavation (when excavation occurs)
6. North arrow
7. Nearby structures such as buildings, landmarks, streets, etc.
8. Sample locations – Identifiers must be placed on the map for each sample location, and those identifiers must match the analytical table provided for all samples (see Section 2.4.4)

Note: Sample identification on the drawing must match the label on each sample container and chain-of-custody record.

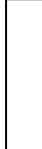
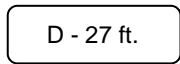
The following symbols are to be used in the site drawing. A sample site drawing can be found in Appendix F. A site drawing form template (UST-ENF-06) can be found in Appendix G and on the LDEQ website at <http://www.deq.louisiana.gov> (DIVISIONS » Underground Storage Tank and Remediation Division » Underground Storage Tank Quick Link to UST Forms).

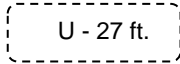
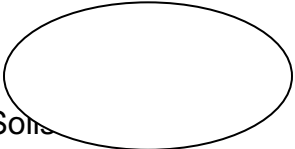
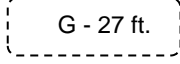
| ● T1 Indicates assigned sample number and location for Tank Sample #1 | ● BF1 Indicates assigned sample number and location for Backfill Sample #1 | ● D1 Indicates assigned sample number and location for Dispenser Sample #1 | ● A1 Indicates assigned sample number and location for Additional Sample #1 |
|---|---|---|--|
|  Tank Area Hd |  Dispenser Island |  D - 27 ft. Indicates a 27 ft. diesel UST was <u>closed-in-place</u> | |
| |  Dispenser |  U - 27 ft. Indicates a 27 ft. used oil UST was <u>removed</u> | |
|  Excavated Soil | |  G - 27 ft. Indicates a 27 ft. gasoline UST was <u>removed</u> | |

2.4.4 Laboratory Analytical Results Table

A Laboratory Analytical Results Table in tabular format must be included with all Closure Assessment Reports. The Laboratory Analytical Results Table must include a sample identifier for every sample location. The following sample identifier must be used: “T” for tank native soil samples, “BF” for backfill samples, “D” for dispenser island samples, and “A” for any additional samples. The Laboratory Analytical Results Table must include each sample identifier and sample number, the date collected, the constituents analyzed, the sample depth, the concentration of each constituent analyzed in mg/kg units, the soil vapor screening concentrations for all samples or intervals measured, and the SPLP concentrations where applicable. See Appendix K for an example.

2.4.5 Laboratory Analytical Report and Chain-of-Custody

A copy of the final laboratory analytical report, including all sample results, QA/QC data and the chain-of-custody record, must be included in the Closure Assessment Report.

2.4.6 Manifests

A copy of all manifests, bills of lading or receipts for the disposition of the tank(s), tank contents, and contaminated soil and/or fluids must be included in the Closure Assessment Report.

2.4.7 Conveyance Notification

If a conveyance notification is filed (see Section 8.4), a copy must be included in the Closure Assessment Report.

2.5 Reporting Evidence of a Release

LAC 33:XI.707.A requires all owners, operators, employees, agents, contractors, or assigns having knowledge that evidence exists indicating a release from a UST system must report the contamination to the LDEQ **within 24 hours of discovery**. For UST closures, the UST owner or UST closure contractor must call LDEQ Single Point of Contact (SPOC) within 24 hours of discovery. Notification should also be made to the appropriate LDEQ UST Division Regional Office in order to discuss all options that are available to close the site.

If **any** of the constituents analyzed exceeds the **Limiting Soil Standard** listed in Appendix M, Column A, or if free-phase product is discovered during the closure, the UST owner or UST closure contractor must notify the LDEQ SPOC by either calling (225) 219-3640 or (225) 342-1234, reporting the incident on-line at <http://www.deq.louisiana.gov> (Online Services; Online Incident Reporting), or reporting the incident via email to spoc@la.gov.

In cases where a release results in an emergency condition, the release must be reported to LDEQ **immediately**, but in no case later than one hour, regardless of the amount released. LDEQ Notification Regulations (LAC 33:I.Chapter 39) define “emergency condition” as “any condition which could reasonably be expected to endanger the health and safety of the public, cause significant adverse impact to the land, water or air environment, or cause severe damage to property.” If an emergency condition occurs and no LDEQ representative is on-site, call the Louisiana State Police at (225) 925-6595 as soon as possible within the first hour of the emergency.

SECTION 3 – GENERAL CLOSURE GUIDELINES

3.1 General Information

The UST regulations (LAC 33:XI.907.A) require that UST owners measure for the presence of a release where contamination is most likely to be present at a UST site before permanent closure or change-in-service is completed. To do this, soil samples must be collected as described in Section 4 of this document. All samples must be collected and analyzed following the appropriate EPA SW-846 method as outlined in Section 7. All analytical results must be screened according to the UST Soil Screening Standards listed in Appendix M. The analytical results will be used to determine whether additional assessment or if soil or groundwater cleanup is required. Section 8 includes instructions on conducting additional analyses — synthetic precipitation leaching procedure (SPLP) and total petroleum hydrocarbon (TPH) fraction analysis — which can be applied in order to successfully close out a site. Section 8 also includes instructions on the use of conveyance notices whenever residual soil concentrations are between non-industrial and industrial screening standards.

3.2 Accredited Laboratories

All closure samples must be submitted to an accredited laboratory for analysis. A list of accredited laboratories is available on the LDEQ website at <http://www.deq.louisiana.gov> (DIVISIONS » Public Participation and Permit Support; Louisiana Laboratory Accrediation Program; Accredited Laboratories).

3.3 Ozone Action Days

It is recommended that vapor-freeing USTs and excavating at UST sites contaminated with volatile organic constituents should not take place on Ozone Action Days. During ozone season (May 1 – September 30), ozone forecasts can be found on the LDEQ website at <http://www.deq.louisiana.gov> (DIVISIONS » Air Permits, Engineering and Planning » National Ambient Air Quality Standards » Ozone » Daily Ozone and PM2.5 Forecast). Any air quality condition categorized in the ozone forecast as “Unhealthy for Sensitive Groups”, “Unhealthy”, “Very Unhealthy”, or “Hazardous” is considered an Ozone Action Day. Specific air quality reports per region can be found on the LDEQ website at <http://www.deq.louisiana.gov> (DIVISIONS » Air Permits, Engineering and Planning and clicking on the quick link ozone). UST contractors can receive up-to-date air quality information electronically via email, cell phone, or pager by subscribing to EnviroFlash found on the LDEQ website at <http://www.deq.louisiana.gov> (DIVISIONS » Assessment » Air Field Services » Enviroflash).

3.4 Recommended Safety Practices

The purpose of this section is to encourage safe UST closure practices. Proper work practices will keep contractors, employees, passers-by, and the environment safe. LAC 33:XI.905.D requires following certain reference and guidance documents when cleaning and closing USTs. This section should be used for informational purposes only, as it does not contain all of the rules or reference documents required by LDEQ regulations. A list of industry codes and standards that are referenced in the UST regulations relating to closing USTs can be found in Appendix A.

3.4.1 Site Safety

All personnel working in the UST closure area should be familiar with the potential hazards and be aware of the appropriate health and safety measures needed to ensure a safe working environment. Employees must be advised of the chemical, physical, and toxicological properties of each substance that is known or expected to be present in the UST. Due to the nature of the flammable or combustible liquids stored in the UST, hazardous conditions should be expected to exist in the UST closure area.

Some recommended site safety practices are:

- Call Louisiana One Call (811 or 1-800-272-3020) at least 48 hours prior to any excavation activities. In 1988, the Louisiana Underground Utilities and Facilities Damage Prevention Law became effective. This law requires excavators and demolishers to call a regional notification center at least 48 hours before beginning work. It also requires owner/operators of underground facilities to mark locations or supply information that will enable excavators and demolishers to locate underground utilities and facilities.
- Observe any overhead obstructions or nearby buildings that may interfere with the UST closure.
- Keep the UST closure area free of all sources of ignition. Confirm that all electrical service going to, under, or through the UST closure area is disconnected.
- Plan a safe working area by providing sufficient space for workers and equipment. Erect and maintain brightly colored barricades around the work space. The American Petroleum Institute (API) recommends placing barricades 50 feet in all directions from the edge of the excavation where possible. Consider traffic flow when barricading your work space. Since many locations are open for business during UST closures, arrange barricades to direct traffic away from the work space.
- Keep a minimum of two fully charged fire extinguishers within easy reach of the work space. Make sure the fire extinguishers are adequate to extinguish chemical fires and provide proper training and use to workers.

- Make sure anyone entering the work space is wearing a brightly colored safety vest and is wearing OSHA Level D personal protective equipment.
- A site-specific Health and Safety Plan (HASP) should be prepared and kept on-site to address potential safety and health hazards encountered in the work space. The HASP should include emergency telephone numbers and locations of the nearest medical facilities. The HASP should designate a site safety and health supervisor who has the authority to stop the project should worker health or safety become jeopardized. The HASP should be reviewed with the workers prior to any site activities and should be evaluated and updated as changing conditions warrant.

3.4.2 Sloping or Shoring the Excavation

The UST closure should be conducted so that no one has to enter the excavation. Entry into an excavation is not only dangerous; it is also considered confined space entry. OSHA requires specific training for employees who must work in a confined space situation. A confined space is a space with limited ventilation, potential to accumulate or contain a hazardous atmosphere, exits that are not readily accessible, and not meant for continuous human occupancy. This includes excavations and trenches. If workers must occasionally enter an excavation, they should be properly trained in OSHA regulations for confined space entry and self-rescue. Compliance with all OSHA regulations for confined space entry and activities is required.

If workers are going to be working within the excavation, then sloping or shoring the excavation is required by OSHA. The OSHA Standard 29 CFR 1926.650-652 requires that employees in an excavation be protected from cave-ins.

There are four sloping options available:

1. Slope the excavation at an angle no steeper than 1½ feet horizontal to 1 foot vertical — expressed 1½:1 (1926.650-652, Subpart P, Appendix B).
2. Slope the excavation in accordance with the OSHA simplified soil classification system, which ranks soils according to their stability (1926.650-652, Subpart P, Appendices A and B).
3. Use a design created and sealed by a Louisiana registered professional engineer.
4. Use a site-specific design sealed by a Louisiana registered professional engineer.

An excavation that will be entered can be sloped ½:1, if it meets these criteria:

- the excavation is in Type A soil (the most stable soil type and is composed of cohesive clay, silty clay, clay loam, and sandy clay with an unconfined compressive strength of 1.5 tons per square foot or greater);
- the excavation will not be open more than 24 hours; and
- the excavation is no deeper than 20 feet.

Even in stable soils, however, if the excavation will be open longer than 24 hours, the sides must be sloped at least ¾:1.

Refer to the OSHA standard on excavation (29 CFR 1926, Subpart P) for more detailed guidance on sloping and shoring requirements.

3.4.3 Purging or Inerting the UST

All underground storage tanks must be emptied, cleaned, and purged or inerted prior to removing the tank from the excavation; prior to filling the tank with a solid, inert material; or prior to placing a non-regulated substance into the tank during a change-in-service.

Caution must always be exercised when handling or working around USTs that have stored flammable or combustible liquids.

Purging is the removal of flammable vapors from a tank. Inerting is the removal or displacement of oxygen from a tank. Both purging and inerting cause flammable vapors to be expelled from the tank.

Whether purging or inerting a UST, these recommended safety practices should be followed:

- Immediately before beginning work in the UST area or on the UST, check for vapor concentrations with a combustible gas indicator (CGI).
- Keep the UST closure area free of all sources of ignition. Vent all vapors at least 12 feet above grade and 3 feet above any adjacent roof lines.
- Dry ice (carbon dioxide [CO₂] in solid form) can be used to inert a UST. API recommends adding a minimum of 1½ to 2 pounds of dry ice per 100 gallons of tank capacity. The dry ice should be shaved or crushed and must be distributed evenly over the greatest possible area of the tank.
- Never enter a tank that has been inerted with CO₂ or nitrogen (N₂) as both of these methods will displace the oxygen inside the tank. If a tank has been inerted, a CGI will be misleading. Most CGI's require 10% by volume of oxygen to operate properly. Use an oxygen indicator to assess a tank that has been inerted. Be extremely careful when using an inert gas to displace the oxygen inside a tank. Inerting can affect the work space by displacing the oxygen outside the tank also.

- When inerting, the only way to know that a tank is safe for removal is to verify with an oxygen meter that the oxygen level in the tank is below 5%.
- Never use exhaust gas from an internal combustion engine to inert a tank.
- Ground all equipment and use low air or gas pressures to prevent a buildup of static electricity.
- Never discharge a CO₂ fire extinguisher into tanks containing a flammable vapor and air mixture.
- Never let the pressure inside a tank exceed 5 pounds per square inch gauge (psig) when introducing compressed air or gases.
- Flammable vapors can regenerate inside a UST even after purging or inerting. Check often for vapor concentrations with a CGI.

For more specific information of purging or inerting a UST, refer to API Publication 1604 and NFPA Publication 30.

3.4.4 Testing Equipment

The tank atmosphere and the excavation area must be tested regularly for flammable or combustible vapor concentrations until the tank is removed from the site.

- A **properly calibrated** combustible gas indicator (CGI) or explosion meter must be used.
- The person doing the testing must be completely familiar with the instrument and what the readings represent.
- Always test the environment for oxygen content first to be sure you can rely on the instrument. CGI's are inaccurate if a tank atmosphere contains less than 10% oxygen, as would happen if you inert a tank.
- If a tank is inerted, use an oxygen indicator to determine the oxygen concentration. Readings that show a tank to be oxygen-deficient should be safe. A fire needs air with at least 11% oxygen to burn.
- Do not take readings through a drop tube.
- Take readings at each end and in the middle of the tank and at a minimum of three levels in the tank: the bottom, center, and top.
- Readings of less than 10% of the lower explosive limit (LEL) must be obtained before a tank is safe to remove from the ground.

3.5 UST System Removal and Labeling

Unless permanently closing a UST system in place, all tanks and piping must be removed from the ground. Ensure that all residues remaining in the tanks and piping are removed and prevented from reaching the soil. Tanks and piping must be emptied and purged or inerted prior to removing from the ground. Plug any openings in the tank, leaving a 1/8 inch hole to prevent over-pressuring due to temperature changes.

Tanks must be labeled prior to removing from the site. API recommends the following information:

- TANK HAS CONTAINED LEADED GASOLINE (use applicable designation, i.e., GASOLINE, LEADED GASOLINE, DIESEL, USED OIL)
- NOT VAPOR-FREE
- NOT SUITABLE FOR STORAGE OF FOOD OR LIQUIDS INTENDED FOR HUMAN OR ANIMAL CONSUMPTION
- DATE OF REMOVAL: MONTH/DAY/YEAR

Tanks that have held leaded gasoline, or if the history is unknown, should also be clearly labeled with the following information:

- TANK HAS CONTAINED LEADED GASOLINE
- LEAD VAPORS MAY BE RELEASED IF HEAT IS APPLIED TO THE TANK SHELL

Tanks should be cut up, crushed, or removed from site as soon as possible. Always retest the tank to ensure that the LEL level is below 10% or the oxygen level is below 5% before the tank leaves the site. Be sure the tank is properly secured before transporting.

3.6 UST Disposal and UST Re-Use

Tanks must be properly disposed in accordance with all applicable federal, state, and local regulations when they are no longer suitable for storing flammable or combustible liquids.

Tanks that are removed from the ground can only be re-used as underground storage tanks if they are recertified by the manufacturer and meet the secondary containment requirement outlined in LAC 33:XI.303.

Approval from the State Fire Marshal or Local Fire Prevention Bureaus should be obtained prior to re-using tanks as aboveground storage tanks.

Tanks that stored gasoline cannot be used as drainage culverts or for storing food or liquids intended for human or animal consumption.

Either a proof of disposal or a bill of sale when transferring ownership is required in the UST Closure Assessment Report.

3.7 Closing UST Systems in Place

Underground storage tanks should only be closed in place whenever removal would potentially damage adjacent equipment or structures or may be physically impossible. Another factor to consider is whether or not excavation is required in order to remediate contamination from the site. An explanation for closing tanks in place should accompany the UST-SURV-01 Form.

Tanks must be emptied and cleaned prior to closing in place. All product, liquids, and accumulated sludge must be removed from the tank(s) and must be properly recycled or disposed. Once the tank has been determined vapor free, filling the tank with a solid inert material through openings in the top of the tank can begin. It is important to fill the tank completely with a solid inert material, such as concrete or sand. After the tank is filled with solid inert material, all tank openings must be covered, plugged, or capped. If excavation was required around the tank to locate tank openings, then the excavation should be backfilled. Disconnect and remove the vent line(s) if accessible. If the vent lines are not accessible, remove the portion above the surface and cap both ends.

When closing UST systems in place, the product piping must be rendered unusable. Piping can be rendered unusable by removing as much piping as possible or filling as much of the piping as possible with a solid inert material. Any accessible piping should be capped.

If laboratory analytical results indicate that further corrective action is warranted, the UST owner, property owner, UST closure contractor, and USTD staff should discuss all available remediation and closure options prior to closing in place.

3.8 Sample Collection Procedures

3.8.1 General Requirements

The importance of using good sampling procedures cannot be overstated. Sample handling should not result in cross-contamination or loss of contaminants. Since gasoline and some other petroleum products consist largely of volatile organic compounds, special care in the sample collection is required due to the high potential for loss of these volatile compounds from the sample. EPA SW-846 Method 5035 must be followed when collecting samples for volatile analysis.

All samples must be collected in the container specified by EPA SW-846 protocol for the appropriate analytical method (Section 7). **Samples should be received**

by the laboratory within 24 hours of collection to ensure that the recommended holding times are not exceeded.

Written documentation in the form of a chain-of-custody record must accompany all samples from the time of collection to the time of delivery to the lab. The possession or custody of samples must be traceable from the time of collection until the time the sample is submitted to the laboratory for analysis. The sample containers must be either secured to prevent tampering and placed in a designated, secured area or kept in the actual physical possession of the sampler.

If chain-of-custody procedures are not followed, the integrity of the samples is compromised and the analysis is considered invalid.

3.8.2 Sample Labeling

The sampler must label the sample container with a sample tag (usually an adhesive label) using waterproof ink at the time of sample collection. The sample tag must include the following information:

1. Sample identification
2. Collection date and time
3. Analysis required
4. Sampler's initials

Note: The sample identification on the site drawing must match the label on the sample container.

3.8.3 Chain-of-Custody Record

A chain-of-custody record must be completed for all samples that will be analyzed by the laboratory. This record must be filled out in the field at the time of sampling. The chain-of-custody must accompany the samples as they are transferred to the laboratory. Upon transfer of the samples, each person handling the samples must sign, date, and note on the record the time they received the samples.

Each chain-of-custody record must include:

1. Sample identification
2. Name and address of the site
3. Date and time of sample collection
4. Location of each sample
5. Number of samples
6. Analysis to be performed
7. Comments or remarks section (e.g., field conditions)
8. Appropriate places for signatures of sampler and person(s) assuming custody of sample and the identification of common carriers

Completed chain-of-custody records must be submitted for all samples and included with the UST Closure/Assessment report.

SECTION 4 – CLOSURE SAMPLE LOCATIONS

4.1 General Requirements

The goal of collecting and analyzing UST system closure samples is to determine if contamination exists at a UST site as accurately as possible while at the same time minimizing the number of samples necessary to achieve this stated purpose. Properly assessing the site is not only protective of the environment, but protects the current property owner, any future property owners, and any users of the property as well.

UST closure samples can be collected during UST system excavation and removal (Section 4.2) or from soil borings conducted prior to UST system removal or closing UST systems in place (Section 4.3). Although the sample numbers and locations described in this document are the minimum number of samples necessary, they are not intended to substitute for the conditions that may exist at the site. Professional judgment is necessary in order to properly assess and evaluate a site in order to determine if a release has occurred. UST owners may elect to collect additional investigation samples if the initial closure samples appear contaminated in order to identify the vertical and horizontal extent of contamination.

Any areas of obvious contamination must be included in the sampling, and additional samples beyond those specified in this document may be required at the discretion of the Department in order to ensure protection of human health and the environment.

Proposed sample locations that differ from those outlined in this document should be requested from LDEQ prior to the submittal of the UST-SURV-01 form, and must be included with its submittal. Approval of the proposed sampling locations must be received from the appropriate UST Division Regional Office prior to initiation of closure activities.

4.1.1 Soil Vapor Screening

Soil vapor screening can be used in order to reduce the number of samples submitted for analysis as described in the following sections. If soil vapor screening is utilized, in order to properly evaluate sample locations soil vapor screening must be conducted on every sample location identified in Sections 4.2 and 4.3 utilizing a photoionization detector (PID), a flame ionization detector (FID), or any other instrument capable of evaluating organic soil vapors. Soil vapor analyzers must be properly calibrated and maintained. LDEQ field inspectors may check calibration documentation and operation of soil vapor analyzers. If any soil vapor analyzer is determined not to be functioning properly or not properly calibrated, all soil sample locations identified in Sections 4.2 or 4.3 must be analyzed. If soil vapor screening is utilized, the soil vapor concentrations for each sample location or interval measured must be listed on the Laboratory Analytical Results Table as described in Section 2.4.4.

4.2 Closure Samples Collected During Excavation and Removal

When tanks are closed by excavation and removal, samples can be collected either with or without conducting soil vapor screening. Soil samples must be collected from both backfill and native soil immediately after each tank is removed. Native soil samples should be collected from a depth of approximately one foot into the native soil below each tank. Backfill samples can be collected directly below each tank as indicated, or all backfill may be removed from the excavation and stockpiled. If all backfill is removed and stockpiled, follow Section 4.2.5, Backfill Sampling Procedures and Locations. Sampling of pea gravel backfill is not required unless the pea gravel is visibly saturated with product.

4.2.1 Closure Sample Locations for Tanks Less Than 7 Feet Long

One closure sample per tank must be collected in native soil from beneath the center of each tank (Figure 1).

One backfill sample must be collected in backfill beneath each end of each tank (2 samples per tank; see Figure 1).

If groundwater is encountered, one closure sample must be collected in native soil from opposite sidewalls at the soil-groundwater interface (2 samples per tank hold; see Figure 2).

If groundwater is encountered, one discrete backfill sample from three separate locations approximately one foot within the backfill stockpile must be collected (3 samples from backfill; see Figure 2).

If soil vapor screening is utilized, collect soil samples from the same locations as stated above. Conduct soil vapor screening on the soil samples and submit the one closure sample for analysis that exhibits the highest soil vapor concentration and the one backfill sample for analysis that exhibits the highest soil vapor concentration for each tank (2 samples per tank).

FIGURE 1

Tanks Less Than 7 Feet Long
(When Groundwater Is Below the Excavation)

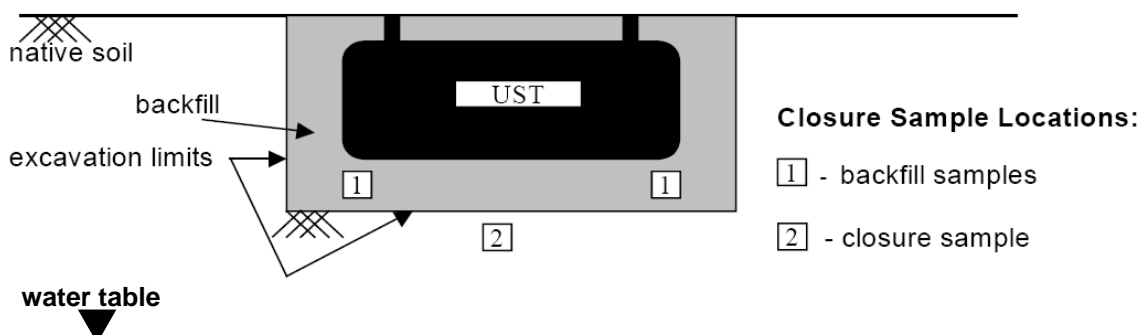
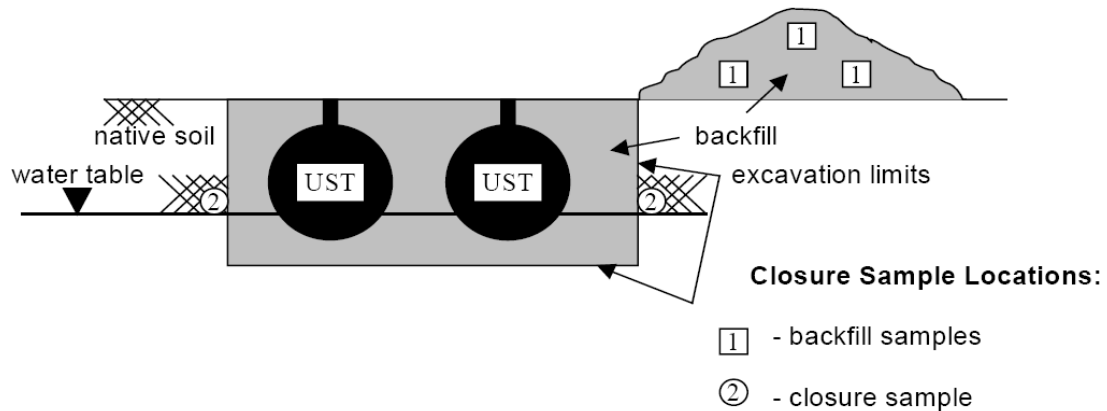

FIGURE 2

**Tanks Less Than 7 Feet Long
(When Groundwater Is Within the Excavation)**



4.2.2 Closure Sample Locations for Tanks 7–35 Feet Long

One closure sample must be collected in native soil from beneath each end of each tank (2 samples per tank; see Figure 3).

One backfill sample must be collected in backfill from beneath each end of each tank (2 samples per tank; see Figure 3).

If groundwater is encountered, collect one closure sample in native soil at each end of each tank at the soil–groundwater interface (2 samples per tank; see Figure 4).

If groundwater is encountered, collect one discrete backfill sample from three separate locations approximately one foot within the backfill stockpile (3 samples from backfill; see Figure 4).

If soil vapor screening is utilized, collect soil samples from the same locations as stated above. Conduct soil vapor screening on the soil samples and submit the one closure sample for analysis that exhibits the highest vapor concentration and the one backfill sample for analysis that that exhibits the highest vapor concentration for each tank (2 samples per tank).

4.2.3 Closure Sample Locations for Tanks Greater Than 35 Feet Long

Sample locations for tanks greater than 35 feet long will be addressed on a site-by-site basis. Proposed sample locations should be requested from LDEQ prior to the submittal of the UST-SURV-01 form, and must be included with its submittal. Approval of the proposed sampling locations must be received from the appropriate UST Division Regional Office prior to initiation of closure activities.

FIGURE 3

Tanks 7–35 Feet Long
(When Groundwater Is Below the Excavation)

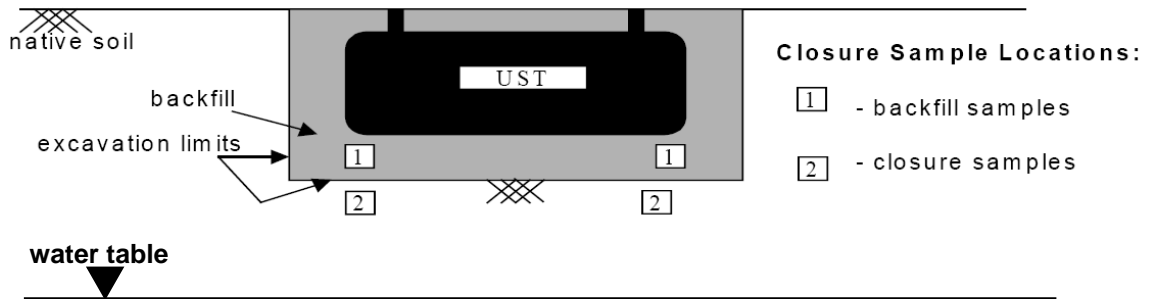
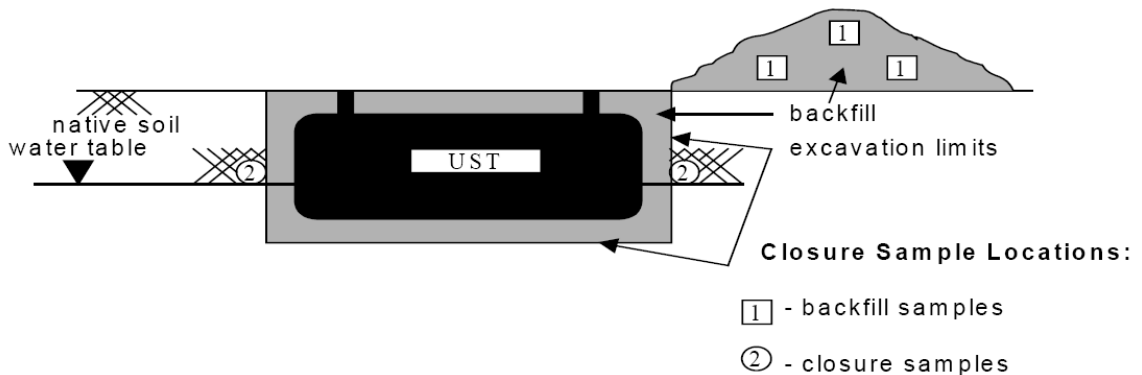

FIGURE 4

Tanks 7–35 Feet Long
(When Groundwater Is Within the Excavation)



4.2.4 Dispenser Sample Procedures and Locations

Soil samples must be collected below each dispenser that is taken out of service. Closure samples are not required to be collected below dispensers that remain in service.

One closure sample must be collected in native soil from beneath each dispenser at either the backfill–native soil interface or at a depth not greater than one foot below the base of the piping trench (1 sample per dispenser; see Figure 5).

If groundwater is encountered, collect one closure sample in native soil from beneath each dispenser at the soil–groundwater interface (1 sample per dispenser; see Figure 6).

For dispensers that are located within five feet of each other, soil vapor screening may be utilized to minimize dispenser sample numbers. Collect soil samples under each dispenser as described above and conduct soil vapor screening on each sample. Submit the one closure sample for analysis that exhibits the highest vapor concentration from the dispenser samples that are located within five feet of each other.

If dispensers are located directly above tanks within the perimeter of the tank hold, dispenser samples are not required if the tanks are being removed.

FIGURE 5

Dispenser Sample Locations

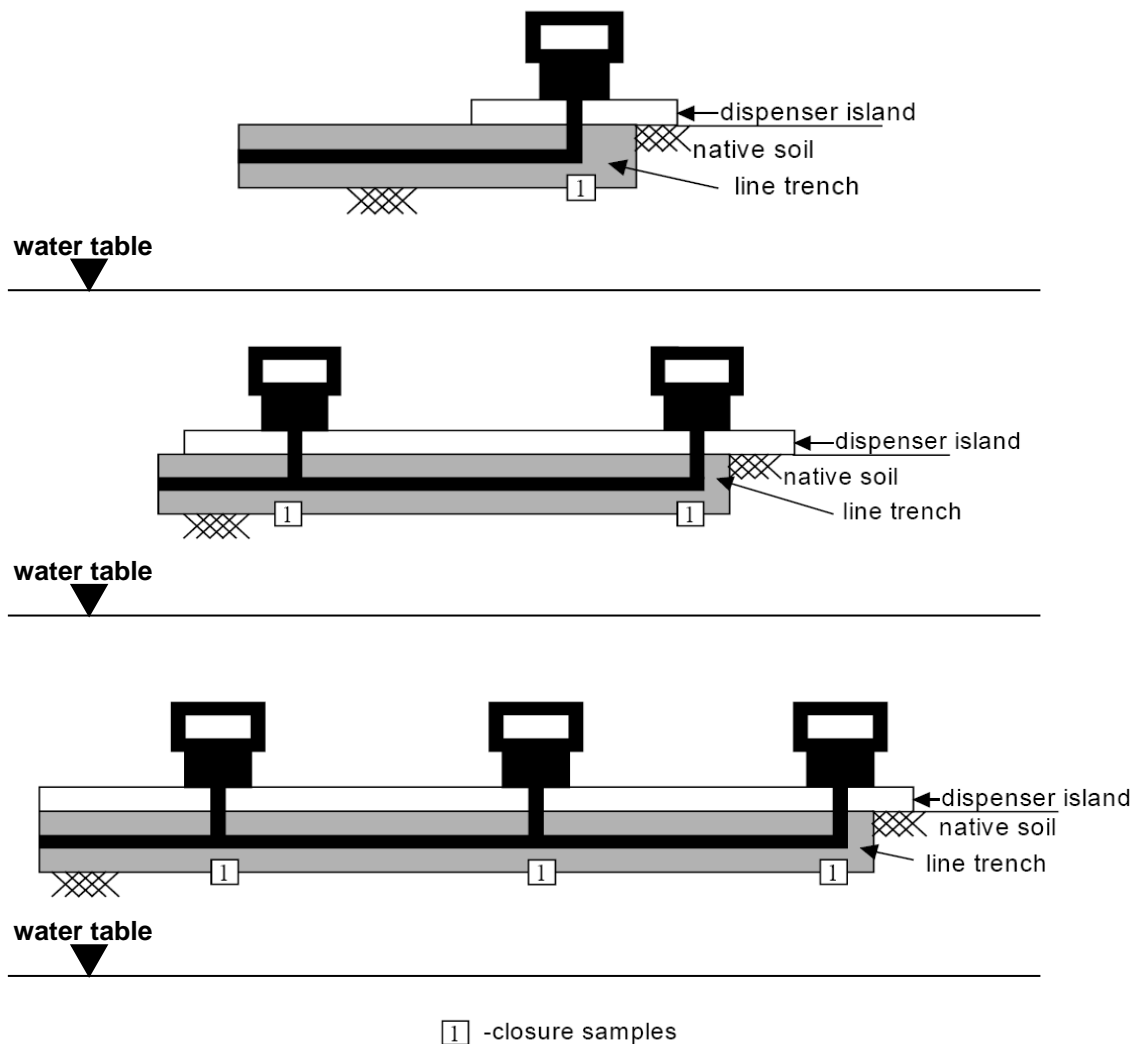
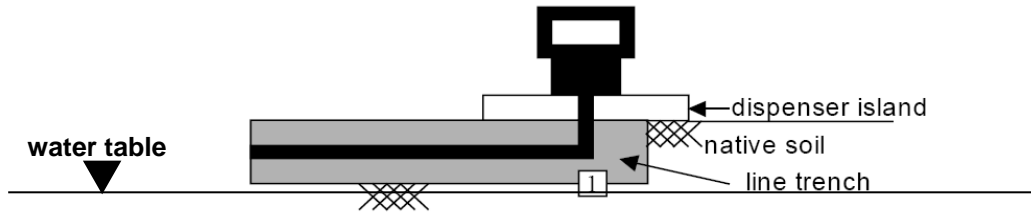

FIGURE 6

**Dispenser Sample Locations
(When Groundwater Is Encountered)**



4.2.5 Backfill Sample Procedures and Locations

Backfill samples are required for all closures performed by excavation unless the backfill is removed and disposed at an acceptable landfill. If excavated backfill is to be disposed at an acceptable landfill, sampling may be required if Motor Fuel UST Trust Fund reimbursement is applied for. If groundwater is not encountered, backfill samples can either be collected as described in Figures 1 and 3, or all of the backfill can be excavated from the tank hold and backfill samples collected from the stockpile as described below. If groundwater is present in the excavation, then backfill samples must be collected from the stockpile as described in Figures 2 and 4 and below.

A minimum of three backfill samples are required for backfill stockpile sampling. Samples shall be collected as soon as possible but no later than four hours after the backfill is excavated. Backfill stockpile samples should be collected at a point at least one foot into the stockpile, and obviously contaminated areas must be sampled.

All potentially contaminated soils stored on-site must be placed on and covered with an impervious material. Measures shall be taken to prevent any surface runoff from entering into or washing away from the stockpile. For safety reasons, all excavated areas should be filled or adequately secured from the public as soon as possible.

Sampling of pea gravel backfill is not required unless the pea gravel is visibly saturated with product.

4.3 Closure Samples Collected From Soil Borings

UST closure samples may be collected utilizing boring equipment capable of producing samples that meet the appropriate sampling protocol. The equipment used to advance soil borings shall consist of hollow stem auger, solid stem auger, direct push technology, or other methods approved by LDEQ. Hand augers may be allowed if samples collected are not intended for volatile organic analysis or if site conditions make other methods impractical. All investigation derived wastes (cuttings, water, etc.) must be collected and properly disposed in accordance with applicable LDOTD and LDEQ regulations.

Soil borings should be installed as close to the edges of the tank hold area as possible, but in no case greater than 5 feet from the tank edge unless groundwater is present and native soil samples cannot be collected at the groundwater interface within five feet from the tank. The required number of tank closure samples is based on the length of the tank hold as described in Sections 4.3.1 to 4.3.4 below.

When sampling soil, undisturbed continuous samples are to be collected from each boring location to determine the vertical depth of impact. At a minimum, sampling shall continue until at least one foot below the base of the nearest UST.

Only native soil samples are required to be collected for analysis during soil boring assessments. If backfill is encountered and is visibly contaminated, backfill samples should be submitted for analysis also. If a UST system assessed by the soil boring method is removed at a later date instead of being closed in place, backfill sampling may be required at that time if the backfill was not addressed in the soil boring sampling.

4.3.1 Tank Hold Lengths Less Than 10 Feet

Collect one closure sample in native soil from either the two sides of the tank hold or the two ends of the tank hold at a depth of one foot below the base of the tank, for a total of 2 samples (Figures 7 and 8).

If groundwater is encountered, collect one closure sample in native soil from either the two sides of the tank hold or the two ends of the tank hold at the soil–groundwater interface.

If soil vapor screening is utilized, collect one closure sample in native soil from the two-foot interval that exhibits the highest vapor concentration from each soil boring. Submit the one closure sample that exhibits the highest vapor concentration collected from opposing borings for analysis. For example, in Figures 7 and 8, the one sample interval exhibiting the highest soil vapor concentration from the two borings labeled number 1 is required to be submitted for analysis.

If two or more intervals in one boring have equally elevated soil vapor concentrations, submit the deeper interval for analysis.

FIGURE 7

Tank Hold Lengths Less Than 10 Feet

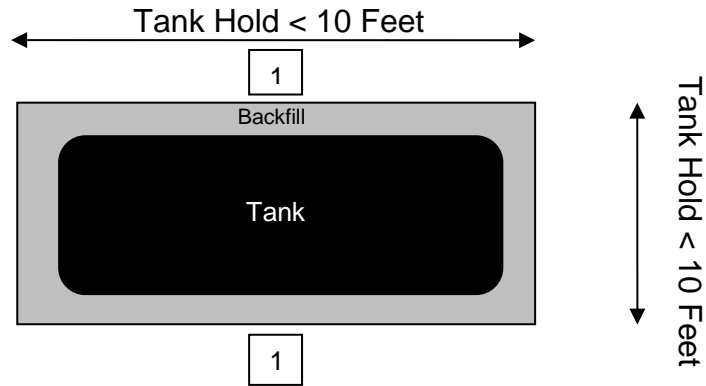
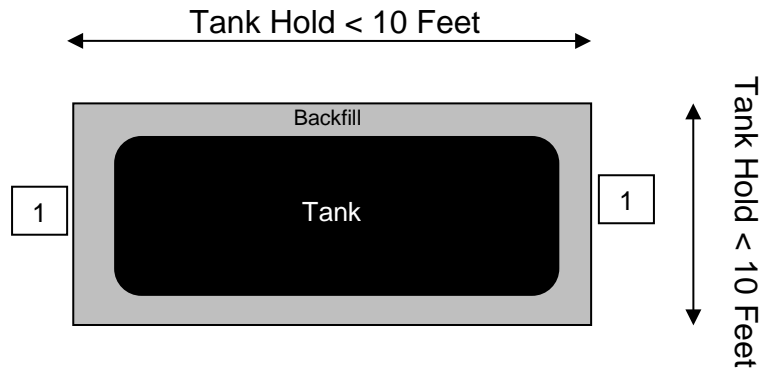

FIGURE 8

Tank Hold Lengths Less Than 10 Feet



4.3.2 Tank Hold Lengths 10 Feet to Less Than 35 Feet

Collect one closure sample in native soil from each of the four sides of the tank hold at a depth of one foot below the base of the tank (Figure 9).

If groundwater is encountered, collect one closure sample in native soil from each of the four sides of the tank hold at the soil-groundwater interface.

If soil vapor screening is utilized, collect one closure sample in native soil from the two-foot interval that exhibits the highest vapor concentration from each soil boring. Submit the one closure sample that exhibits the highest vapor concentration collected from opposing borings for analysis. For example, in Figure 9, the one sample interval exhibiting the highest soil vapor concentration from the two borings labeled number 1 and the one sample interval exhibiting the highest soil vapor concentration from the two borings labeled number 2 are required to be submitted for analysis.

If two or more intervals in one boring have equally elevated soil vapor concentrations, submit the deeper interval for analysis.

FIGURE 9

Tank Hold Lengths 10 to Less Than 35 Feet

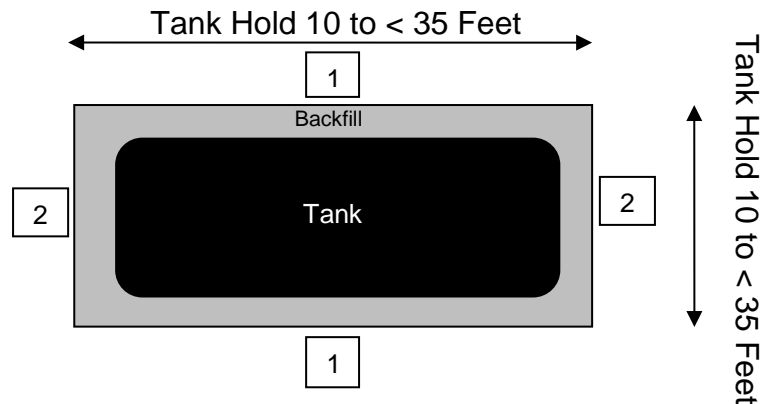

4.3.3 Tank Hold Lengths 35–70 Feet

For tank hold lengths 35–70 feet, advance two soil borings per side and collect one closure sample from each boring in native soil at a depth of one foot below the base of the tank (Figures 10 and 11).

If groundwater is encountered, collect one closure sample in native soil from each boring at the soil–groundwater interface.

If soil vapor screening is utilized, collect one closure sample in native soil from the two-foot interval that exhibits the highest vapor concentration from each soil boring. Submit the one closure sample that exhibits the highest soil vapor concentration from the two borings from each side for analysis. For example, in Figure 10, the one sample interval exhibiting the highest soil vapor concentration from the two borings labeled number 1, the one sample interval exhibiting the highest soil vapor concentration from the two borings labeled number 2, and the one sample interval exhibiting the highest soil vapor concentration from the two borings labeled number 3 are required to be submitted for analysis.

Also for example, in Figure 11, the one sample interval exhibiting the highest soil vapor concentration from the two borings labeled number 1, the one sample interval exhibiting the highest soil vapor concentration from the two borings labeled number 2, the one sample interval exhibiting the highest soil vapor concentration from the two borings labeled number 3, and the one sample interval exhibiting the highest soil vapor concentration from the two borings labeled number 4 are required to be submitted for analysis.

If two or more intervals in one boring have equally elevated soil vapor concentration values, submit the deeper interval for analysis.

FIGURE 10

Tank Hold Lengths 35–70 Feet

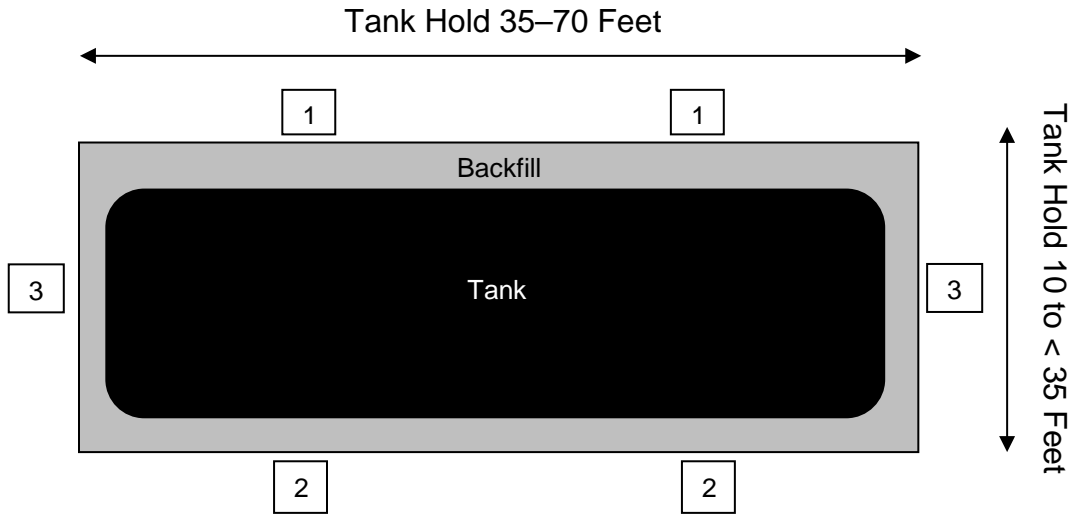
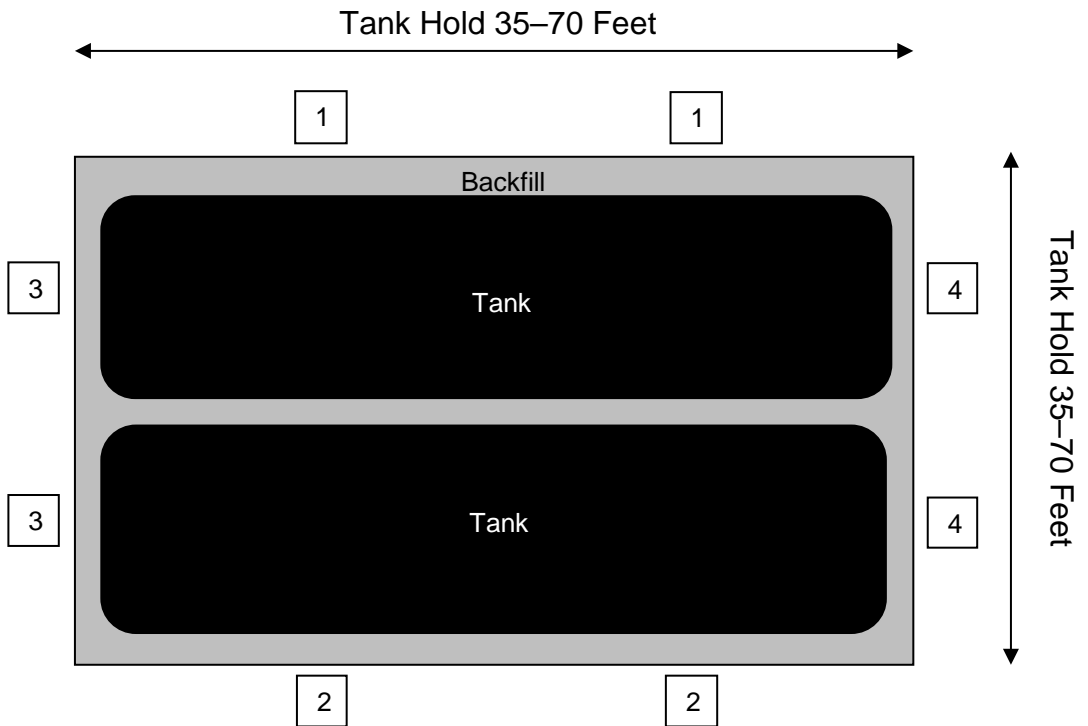

FIGURE 11

Tank Hold Lengths 35–70 Feet



4.3.4 Tank Hold Lengths Greater Than 70 Feet

For tank hold lengths greater than 70 feet, advance three soil borings per side and collect one closure sample from each boring in native soil at a depth of one foot below the base of the tank (Figure 12).

If groundwater is encountered, collect one closure sample in native soil from each boring at the soil-groundwater interface.

If soil vapor screening is utilized, collect one closure sample in native soil from the two-foot interval that exhibits the highest vapor concentration from each boring. Submit the two closure samples that exhibit the highest soil vapor concentrations from the three borings from each side for analysis. For example, in Figure 12, the two sample intervals exhibiting the highest soil vapor concentrations from the three borings labeled number 1, the two sample intervals exhibiting the highest soil vapor concentrations from the three borings labeled number 2, the one sample interval exhibiting the highest soil vapor concentration from the two borings labeled number 3, and the one sample interval exhibiting the highest soil vapor concentration from the two borings labeled number 4 are required to be submitted for analysis.

If two or more intervals in one boring have equally elevated soil vapor concentration values, submit the deeper interval for analysis.

FIGURE 12

Tank Hold Lengths Greater Than 70 Feet

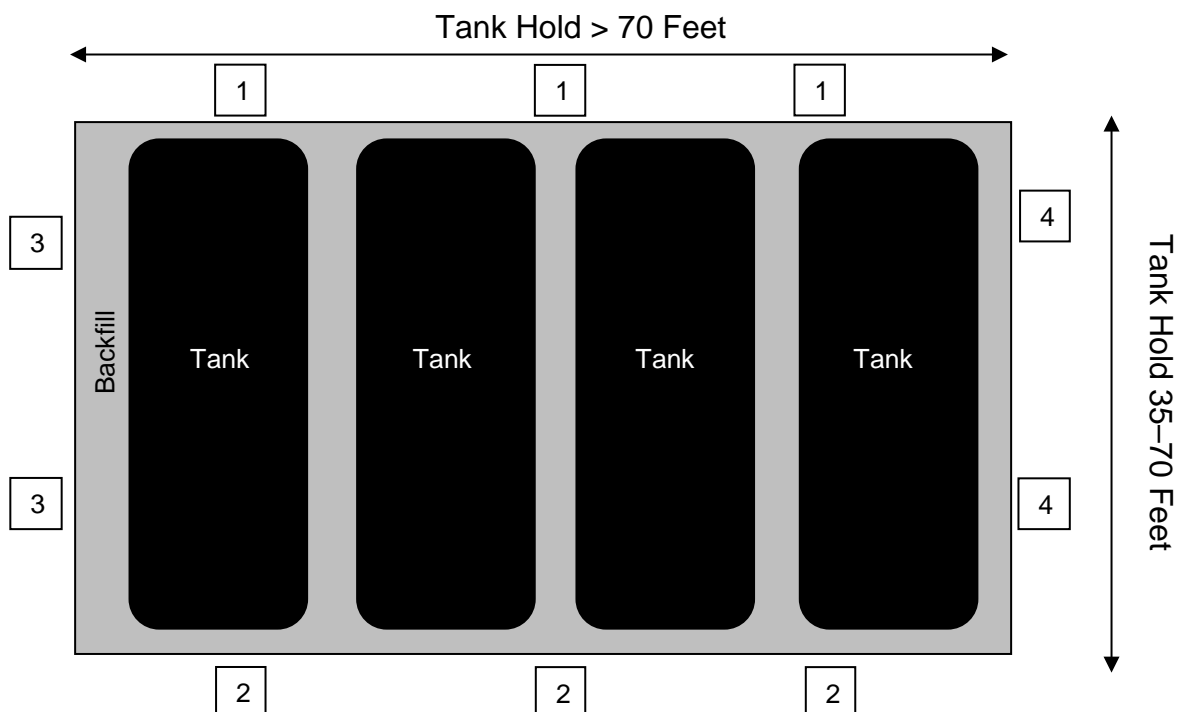

4.3.5 Dispenser Samples Collected From Soil Borings

Advance soil borings as close to each dispenser as possible but not greater than five feet from the dispenser. Soil borings should continue to a depth at least one foot below the base of the piping trench. One closure sample must be collected in native soil from beneath each dispenser at either the backfill–native soil interface or at a depth not greater than one foot below the base of the piping trench (1 sample per dispenser; see Figure 13).

If groundwater is encountered, collect one closure sample in native soil from the boring at the soil–groundwater interface (1 sample per dispenser).

If soil vapor screening is utilized, collect one closure sample in native soil from the two-foot interval that exhibits the highest vapor concentration from each boring (1 sample per dispenser). If dispenser sample locations are located within five feet of each other, submit the one closure sample that exhibits the highest vapor concentration of the sample locations located within five feet of each other for analysis (Figure 14). For multiple dispensers that are all within five feet of one another, a minimum of one sample is required for every two dispensers.

If dispensers are located directly above the tanks and tanks are being removed, no discrete dispenser samples are required as long as the dispensers are located within the perimeter of the tank hold.

FIGURE 13
Dispenser Sample Locations

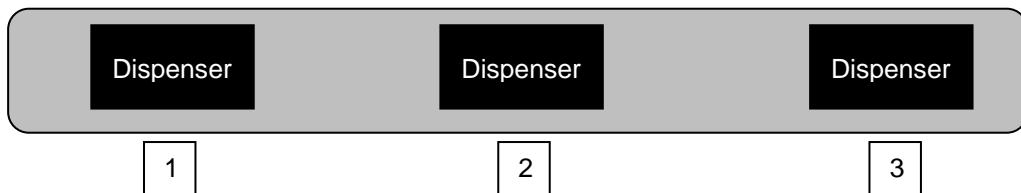
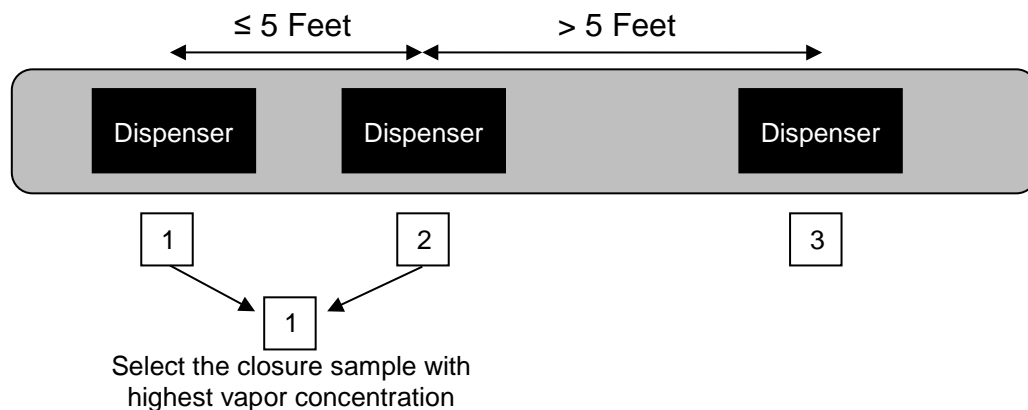

FIGURE 14
Dispenser Sample Locations



SECTION 5 – SAMPLE LOCATION DEVIATIONS

5.1 General Requirements

There are many instances where special circumstances dictate deviations from the sample location or sample results screening requirements outlined in this document. Whenever any of the conditions listed below or any other special circumstances are encountered, consult with the appropriate LDEQ UST Division Regional Office prior to performing the closure.

5.2 Excavating Contamination During UST System Closures

There may be instances where a UST owner may want to expeditiously remediate a UST site during the closure phase, or may want to excavate the existing tank hold after a UST removal in order to install a new UST system. If contamination appears to be present, a limited excavation may be conducted. If excavation is performed during the closure phase after the tank and/or dispenser removal, collecting closure samples at the locations and depths outlined in Section 4 may not be appropriate. Whenever excavation takes place, samples must be collected in the same manner and locations as specified in Section 4, except the sample depth would now be at the base of the excavation. If excavation extends horizontally to remove contaminated material, samples must be collected at each sidewall that is excavated. Soil vapor screening may be used to eliminate sample numbers at the discretion of the UST Division representative overseeing the closure.

Although closure samples in the locations and depths specified in Section 4 may not be appropriate to close the site, analytical results may be required for Motor Fuel UST Trust Fund eligibility determinations.

5.3 Previously Contaminated UST Sites or Sites Currently Undergoing Remediation

There may be instances when UST systems will be permanently closed at a site that has had a previous release. There are many factors that LDEQ will take into consideration when a UST system closure is conducted. Several factors that are considered include if the previous release is currently under remediation, if it has been granted a No Further Action decision, the location of previous assessment borings and type of analyses performed, and whether the tanks have or have not been in use since the previous release.

Whenever UST closures are performed at previously contaminated sites, the UST owner and closure contractor should consult with the LDEQ UST Division Regional Office staff well in advance of the closure and prior to the submittal of the UST-SURV-01 form. The appropriate UST Division Regional Office staff, UST owner, property owner, certified closure contractor, the site's remediation Team Leader, and the Response Action Contractor, if applicable, should discuss site specifics well in advance of the closure.

Sites such as these will be handled by LDEQ on a case-by-case basis, but as a general rule, the following may apply:

- Certain closure samples may be eliminated for areas previously assessed if the tanks did not contain product since the previous release (for example, if only the dispenser islands were previously assessed, then only tank hold samples would be required during the closure).
- Closure samples may be eliminated altogether if the tanks were taken out of service and remained out of service since the previous release and all of the closure sample locations outlined in Section 4 were previously assessed.
- None of the closure sample locations may be eliminated if the tanks were in use since the previous release.
- Analytical results for the closure samples collected may be screened against already established site-specific RECAP standards.
- UST closure samples may not need to be collected if the site is currently contaminated with free-phase product.

5.4 UST Sites Contaminated With Free-Phase Product

The purpose of collecting UST closure samples is to determine if the UST site needs further assessment and/or remediation. Sites that have free-phase product will need remediation and further assessment once the free-phase product has been removed.

Whenever free-phase product is discovered at a UST site, either during the closure or prior to the closure, some closure samples may not need to be collected.

Whenever the presence of free-phase product is known prior to the closure, coordination must be made between the UST owner, property owner, certified closure contractor, appropriate LDEQ UST Division Regional Office staff, the sites remediation Team Leader, and the Response Action Contractor, if applicable, to discuss site specifics well in advance of the closure.

If free-phase product is discovered during a UST closure, immediate notification must be made to LDEQ by following the procedures outlined in Section 2.5 of this document. In addition, free-product removal must begin as soon as practicable in accordance with LAC 33:XI.715.E.

SECTION 6 – TEMPORARY CLOSURE ASSESSMENT REQUIREMENTS

6.1 Temporary Closure Requirements

Temporary Closure is defined in LAC 33:XI.103 as “the temporary removal from service of a UST.” Anytime a UST system is taken out of service, LDEQ considers this tank to be in temporary closure.

For UST systems that have been upgraded with corrosion protection and have been in temporary closure for more than 24 months, LAC 33:XI.903.D requires UST owners or operators to perform a site assessment in accordance with LAC 33:XI.907. The reference to LAC 33:XI.907 requires the sampling locations of the site assessment to be consistent with the UST closure-in-place site assessment sampling requirements outlined in Section 4 of this document.

Proposed sample locations that differ from those outlined in this document must be requested from LDEQ prior to performing the assessment. Approval of the proposed sampling locations must be received from the appropriate UST Division Regional Office prior to initiation of the assessment.

The 24-month site assessment is required only one time as long as the UST system remains empty of product. If the tanks are never returned into service and are permanently closed at a later date, the 24-month site assessment sampling can be used as permanent closure sampling as long as the tanks have remained empty during temporary closure. Additional permanent closure samples may be required if any contamination discovered during permanent closure was not identified during the temporary closure site assessment.

The UST owner, property owner, and contractor performing the assessment should coordinate performance of the 24-month temporary closure assessment with the appropriate LDEQ UST Division Regional Office. LDEQ UST Division Regional Office addresses and contact information can be found on the LDEQ website at <http://www.deq.louisiana.gov> (DIVISIONS » Underground Storage Tank and Remediation Division » Underground Storage Tank » UST Contact Information).

The special considerations outlined in Section 5 of this document should be taken into consideration prior to performing the 24-month temporary closure site assessment. Also, in order to prevent damage to UST systems that may be used in the future, installing soil borings at distances greater than 5 feet from the tank and dispenser edges is allowed.

A 24-Month Temporary Closure Assessment Report must be submitted to the appropriate LDEQ UST Division Regional Office within 60 days of performing the assessment and must include all of the information specified in Section 2.4 of this document, with the exception that the UST Closure Assessment Form is not required until the UST system is permanently closed.

SECTION 7 – SAMPLE ANALYSES

Samples must be analyzed for the product last stored in the UST in the greatest quantity. However, if evidence of a leak from a previously stored product is suspected, the samples should be analyzed for that substance also. The table below indicates the required analyses associated with the product stored in the UST. Enough sample volume must be collected at each sample location to allow for PAH and/or metals analysis on the highest TPH-DRO or TPH-ORO sample. Enough sample volume must also be collected at each sample location to allow for SPLP and TPH Fraction analyses. For substances not listed below, contact the UST Division Regional Office prior to sampling.

| PRODUCT STORED | SAMPLE MEDIA | ANALYSES REQUIRED | EPA SW-846 ANALYTICAL METHODS ¹ | HOLDING TIMES |
|-------------------------------|--------------|--|--|-------------------------|
| Gasoline | Soil | BTEX | 8015, 8021, 8260, 8261 | 48 hours or 14 days |
| | Soil | MTBE | 8015, 8260, 8261 | 48 hours or 14 days |
| | Soil | Lead ² | 6010, 6020, 6200, 6800, 7000, 7010 | 180 days |
| | Soil | TPH-GRO (C ₆ - C ₁₀) | 8015 | 48 hours or 14 days |
| Diesel | Soil | TPH-DRO (C ₁₀ - C ₂₈) | 8015 | 14/40 days |
| | Soil | PAH ³ | 8100, 8270, 8275, 8310 | 14/40 days |
| Used Oil | Soil | TPH-ORO (C _{>28}) | 8015 | 14/40 days |
| | Soil | Total Metals ⁵ | 6010, 6020, 6200 | 28/28 days ⁴ |
| | Soil | PAH ⁵ | 8100, 8270, 8275, 8310 | 14/40 days |
| Kerosene, Jet Fuel | Soil | TPH-GRO (C ₆ - C ₁₀) | 8015 | 48 hours or 14 days |
| | Soil | TPH-DRO (C ₁₀ - C ₂₈) | 8015 | 14/40 days |
| Hazardous or Other Substances | Soil | Analyze by approved method for the substance stored or primary constituent | | |
| SPLP | Soil | Volatiles | Extraction: 1312, Analysis: 8260 | 14/14 |
| SPLP | Soil | Semi-Volatiles | Extraction: 1312, Analysis: 8270 | 14/40 |
| SPLP | Soil | Total Metals | Extraction: 1312, Analysis: 6010 | 28/28 days ⁴ |

¹Use most recent EPA SW-846 update of the selected method. The selected method should be capable of detecting the limiting soil standard.

²Required if facility dispensed gasoline prior to 1/1/86.

³Analyze only on TPH-DRO sample exhibiting highest concentration.

⁴Based on holding time for Mercury (28 days)

⁵Analyze only on TPH-ORO sample exhibiting highest concentration.

BTEX - Benzene, Toluene, Ethylbenzene, and Total Xylenes

TPH - Total Petroleum Hydrocarbons (GRO-Gasoline Range Organics, DRO-Diesel Range Organics, ORO-Oil Range Organics)

MTBE - Methyl tert-butyl ether

SPLP - Synthetic Precipitation Leaching Procedure

Total Metals - Arsenic, Barium, Cadmium, Chromium, Lead, Mercury, Selenium, Silver

PAH - Polynuclear Aromatic Hydrocarbons (Acenaphthene, Acenaphthylene, Anthracene, Benz(a)anthracene, Benzo(a)pyrene,

Benzo(b)fluoranthene, Benzo(k)fluoranthene, Chrysene, Dibenzo(a,h)anthracene, Fluoranthene, Fluorene, Indeno(1,2,3-cd)pyrene,

2-Methylnaphthalene, Naphthalene, Phenanthrene, Pyrene)

48 hours or 14 days - Volatile organic compounds have either a 48 hour or 14 day holding time depending on the Method 5035 option selected.

14/14 - Samples extracted within 14 days and extracts analyzed within 14 days following extraction.

14/40 - Samples extracted within 14 days and extracts analyzed within 40 days following extraction.

28/28 - Samples extracted within 28 days and extracts analyzed within 28 days following extraction.

SECTION 8 – SAMPLE RESULTS INTERPRETATION

8.1 General Information

Sample results must be compared to the UST Soil Screening Standards included in Appendix M. These standards are based on LDEQ's Risk Evaluation/Corrective Action Program (RECAP). If **all** of the measured concentrations of the constituents of concern (COC) for each sample analyzed are less than the Limiting Soil Standards (Appendix M, Column A), the UST Closure/Assessment Report shall be submitted to LDEQ. If **any** of the COCs exceed the Limiting Soil Standards, notify LDEQ SPOC and the appropriate UST Division Regional Office within 24 hours, following the procedures outlined in Section 2.5. If **any** of the COCs exceed the Limiting Soil Standards, further evaluation is required. Further evaluation can consist of additional analysis (TPH Fraction and/or SPLP analysis), limited excavation or placing institutional controls on the property. If the site cannot be closed using one of the methods outlined in this section, then the site will be further evaluated for corrective action by LDEQ UST Division.

8.2 Synthetic Precipitation Leaching Procedure (SPLP)

If the soil/groundwater standard (Appendix M, Column D) is the Limiting Soil Standard (Appendix M, Column A), then Synthetic Precipitation Leaching Procedure (SPLP), EPA SW-846, Method 1312, must be used to possibly eliminate the soil to groundwater pathway and allow the soil to be evaluated with a less stringent limiting standard. As stated in Section 7 above, enough sample volume must be collected at each sample location to allow for SPLP analysis. SPLP analysis is only required on the one sample with the highest concentration per constituent of concern. If the SPLP laboratory result for the constituent is less than the SPLP standard (Appendix M, Column F), then the contaminated soil is not considered to be leaching to groundwater and is therefore protective of groundwater. When the SPLP laboratory result for the constituent is less than the SPLP standard, the limiting soil standard then becomes either the non-industrial soil standard (Appendix M, Column B) or the industrial soil standard (Appendix M, Column C). Refer to the SPLP Decision Flowchart for guidance on performing SPLP analysis (Figure 15).

If the soil to groundwater pathway is eliminated (sample results are either below the soil/groundwater standard or the SPLP analysis results are below the SPLP standard), then the non-industrial soil standard becomes the Limiting Soil Standard. The site may be closed to either the non-industrial or the industrial soil standard, as explained in Section 8.4 below. If any contamination levels above the SPLP standard remains, the site will be referred to LDEQ UST Division for further evaluation.

FIGURE 15

SPLP Decision Flowchart

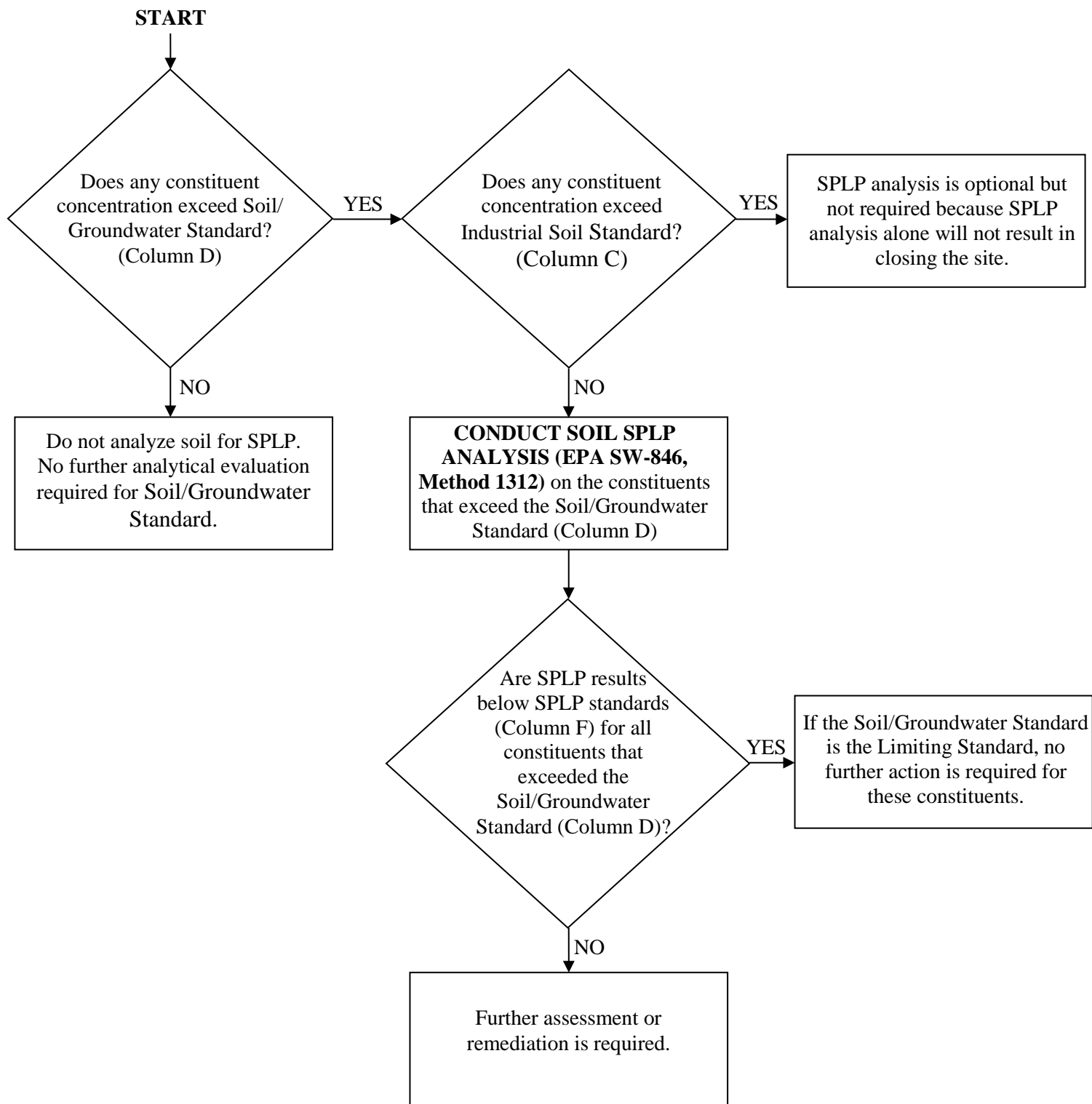

8.3 Total Petroleum Hydrocarbon (TPH) Fraction Analysis

If the Total Petroleum Hydrocarbon (TPH) mixture (TPH-GRO, TPH-DRO, and/or TPH-ORO) concentration exceeds the respective TPH Limiting Soil Standard, then analyzing for TPH fractions is required. As stated in Section 7 above, enough sample volume must be collected at each sample location to allow for TPH fraction analysis. TPH fraction analysis is only required on the sample that exhibits the highest specific TPH mixture concentration. For example, if sample concentrations are above the Limiting Screening Standard for both TPH-GRO and TPH-DRO, conduct TPH fraction analysis on the one sample that exhibits the highest TPH-GRO concentration and the one sample that exhibits the highest TPH-DRO concentration. If the cumulative TPH mixture concentrations exceed 10,000 mg/kg, contact the appropriate UST Division Regional Office prior to conducting fractionation analysis.

The analytical methods suggested for the identification of the designated hydrocarbon fractions include the Massachusetts Department of Environmental Protection's VPH/EPH (volatile petroleum hydrocarbons/extractable petroleum hydrocarbon) Method and the Texas Commission on Environmental Quality Method 1006. When requesting these analyses, the data user must specify that the carbon ranges to be reported match those found in Table 1 below, and that the results be reported on a "wet-weight" basis.

If TPH fractionation data and TPH mixture data have both been collected at an AOI and the two data sets yield different conclusions concerning management of the AOI, then management decisions shall be based on the fractionation data since the fractionation method yields more specific information regarding the TPH constituents present and thus more accurately characterizes site conditions. Refer to the TPH Fraction Decision Flowchart for guidance on analyzing for TPH fractions (Figure 16).

Table 1: Appropriate Hydrocarbon Fractions for Hydrocarbon Mixtures

| Indicator Compound | TPH-GRO C _{>6} - C ₈ (Purgeable) | TPH-DRO C ₁₀ - C ₂₈ (Extractable) | TPH-ORO C _{>28} (Extractable) |
|--|--|--|--|
| Aliphatics C _{>6} - C ₈ | X | | |
| Aliphatics C _{>8} - C ₁₀ | X | | |
| Aliphatics C _{>10} - C ₁₂ | | X | |
| Aliphatics C _{>12} - C ₁₆ | | X | |
| Aliphatics C _{>16} - C ₃₅ | | X | X |
| Aromatics C _{>8} - | X | | |

| | | | |
|--|--|---|---|
| C ₁₀ | | | |
| Aromatics C _{>10} - C ₁₂ | | X | |
| Aromatics C _{>12} - C ₁₆ | | X | |
| Aromatics C _{>16} - C ₂₁ | | X | |
| Aromatics C _{>21} - C ₃₅ | | | X |

FIGURE 16

TPH Fraction Decision Flowchart

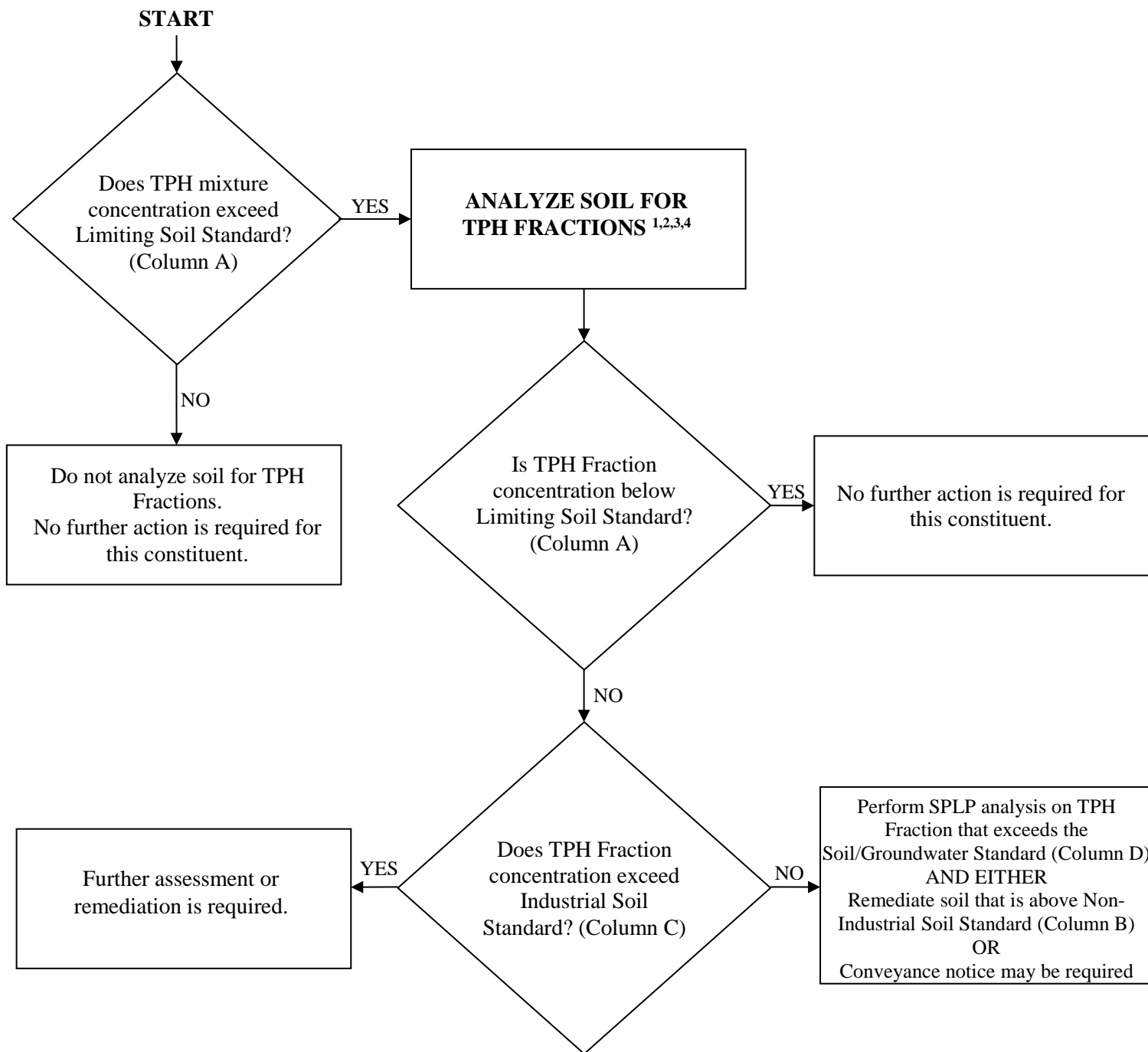

Notes:

1. Suggested analytical methods:
 - a. Massachusetts Department of Environmental Protection VPH/EPH (Volatile Petroleum Hydrocarbons/Extractable Petroleum Hydrocarbon) Method
 - b. Texas Commission on Environmental Quality Method 1006
2. Data user must specify that the carbon ranges to be reported match those in Section 8.3, Table 1
3. Results must be reported on a "wet-weight" basis
4. TPH fraction analysis is only required on the sample that exhibits the highest specific TPH mixture concentration

8.4 Conveyance Notice Filing

A conveyance notice meets the requirements of an institutional control in accordance with RECAP, Section 2.17, and is a legal instrument recorded in the parish conveyance records for the subject property. A conveyance notice filing is required for properties that have residual soil contamination with constituent concentrations that exceed non-industrial soil standards but are less than industrial soil standards. If the constituent concentrations in the residual soil contamination do not exceed non-industrial soil standards, then a conveyance notice filing is not required.

Should the UST owner and property owner choose to close the site to the industrial soil standard, any contaminated soil exceeding the industrial soil standard must be remediated to the industrial soil standard and the site can then be closed by filing a conveyance notice. If any contamination levels above the industrial soil standards remain, the site will be referred to LDEQ UST Division for further evaluation. Refer to the Conveyance Notice Decision Flowchart for guidance on filing a conveyance notice (Figure 17).

If a conveyance notice is going to be used in lieu of remediating to non-industrial soil standards, the property owner must be consulted prior to filing the conveyance notice. The draft conveyance notice must be submitted to the UST Division Regional Office for review and approval prior to filing the notice at the appropriate Parish Courthouse. The conveyance notice must be completed and filed at the appropriate Parish Courthouse within 60 days of the closure. Contact the appropriate UST Division Regional Office to determine if conveyance notice filing is appropriate and to request additional time if needed.

A sample Conveyance Notification Form Letter is included in Appendix I.

FIGURE 17

Conveyance Notice Decision Flowchart

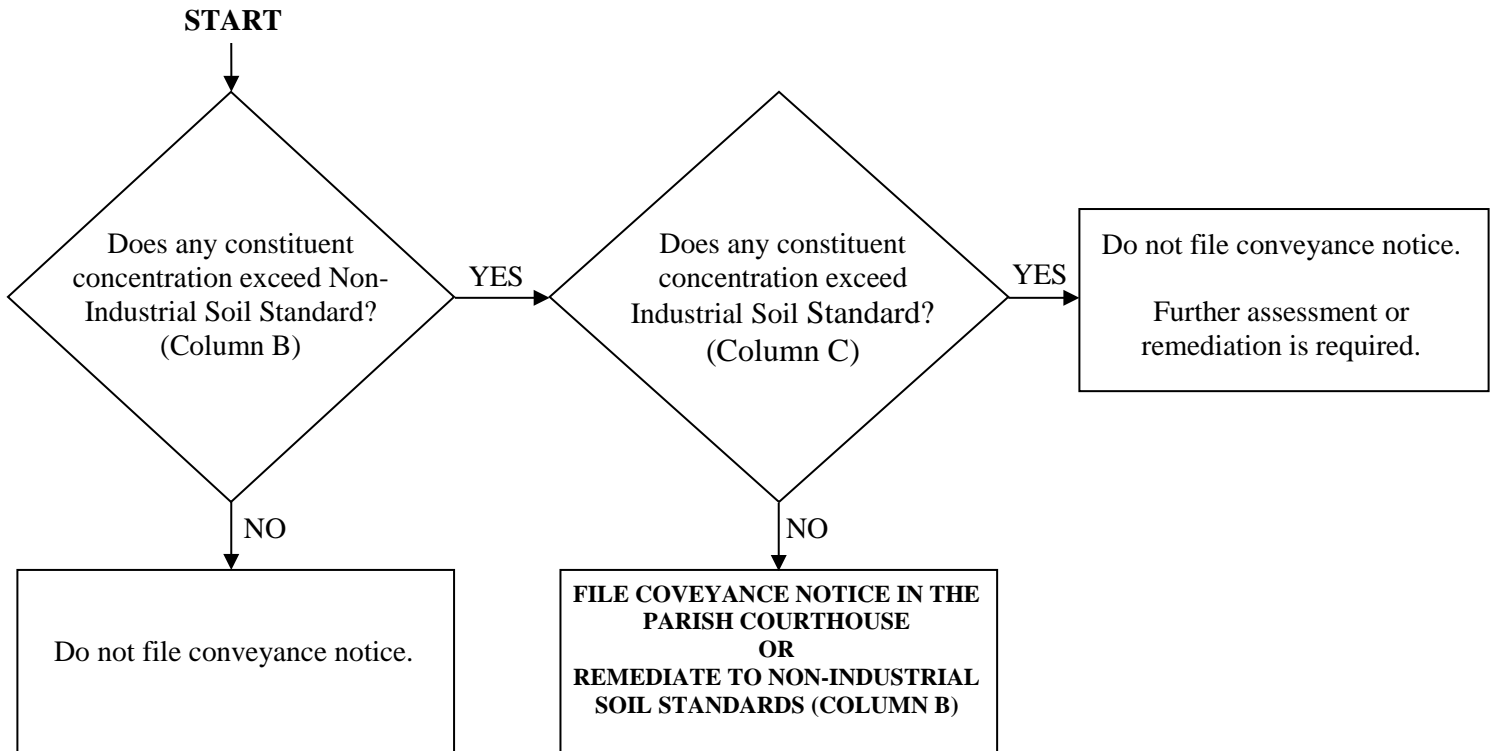

8.5 Enclosed Structure Evaluation

An enclosed structure is defined as an occupied (or potentially occupied) structure on a slab foundation that has a roof and walls on all sides which prevent the free exchange of indoor air with outdoor (ambient) air. If an enclosed structure is located within 10 feet of a UST system soil sampling location, then the residual soil constituent concentration may be further evaluated using the enclosed structure soil standards. This evaluation will be determined on a site-specific basis by LDEQ UST Division.

SECTION 9 – CONTAMINATED SOIL RE-USE OR DISPOSAL

9.1 General Information

Contaminated soil generated during UST closure activities must be managed properly. Contaminated soil must be either returned to the tank hold, re-used either on-site or off-site, or properly disposed. Contaminated soil that is returned to the tank hold where it originated must be managed using the UST Soil Screening Standards outlined in this document.

9.2 Contaminated Soil Re-Use

Whenever contaminated soil is re-used on-site at a different location other than where it originated or re-used at an off-site location, the Soil Re-Use section in the latest edition of LDEQ's Risk Evaluation/Corrective Action Program (RECAP) must be followed.

9.3 Contaminated Soil Disposal

Contaminated soil that is disposed is subject to solid and hazardous waste regulations. Non-hazardous contaminated soil may be disposed at solid waste disposal facilities permitted to receive industrial solid waste. A list of Louisiana industrial solid waste facilities can be found in Appendix L. Contaminated soil that has been determined to be hazardous must be disposed at a hazardous waste disposal facility. Contact the appropriate disposal facility to determine the applicable waste profile requirements. For information about hazardous waste accumulation time, transporters, disposal, and disposal facilities, contact the appropriate LDEQ Regional Office Surveillance Division.

SECTION 10 – CONTAMINATED WATER DISCHARGE OR DISPOSAL

10.1 General Information

Contaminated water may be generated during tank cleaning activities and during tank hold de-watering activities. Contaminated water generated during any UST closure activity must be managed properly. Contaminated water may be discharged if a water discharge permit is obtained or properly disposed.

10.2 Water Discharge Permit

A permit from LDEQ Permits Division must be obtained prior to discharging ground or surface waters which have accumulated in the tank hold. Contact the Permits Division, Municipal and General Permits Section at (225) 219-3181 for information regarding water permits.

10.3 Contaminated Water Disposal

Tank wash water generated during tank cleaning operations or water that accumulates in a tank hold can be recycled at an appropriate recycling facility. Contaminated water not destined for recycling is subject to solid and hazardous waste regulations.

Non-hazardous contaminated water may be disposed at solid waste disposal facilities permitted to receive industrial solid waste. A list of Louisiana industrial solid waste facilities can be found in Appendix L. Contaminated water that has been determined to be hazardous must be disposed at a hazardous waste disposal facility. Contact the appropriate disposal facility to determine the applicable waste profile requirements. For information about hazardous waste accumulation time, transporters, disposal, and disposal facilities, contact the appropriate LDEQ Regional Office Surveillance Division

SECTION 11 – RECORD KEEPING

The owner and operator must **keep permanent records** of the UST closure and should document the UST closure procedure. Permanent records include:

- DEQ approved “*Notification of Intent to Perform a Closure or Change-In-Service to an Underground Storage Tank*” (UST-SURV-01) form
- DEQ approved “*Underground Storage Tank Closure/Assessment Form*” (UST-SURV-02) and all accompanying documents/records, such as site drawings, analytical results, manifests, conveyance notice, etc.
- all correspondence with DEQ
- photographs of the tank closure activities (recommended)

APPENDIX A

Recommended Industry Codes and Standards for Underground Storage Tank Closure or Change-in-Service

“Removal and Disposal of Used Underground Storage Tanks”
American Petroleum Institute Recommended Practice 1604

“Cleaning Petroleum Storage Tanks”
American Petroleum Institute Publication 2015

“Interior Lining of Underground Storage Tanks”
American Petroleum Institute Publication 1631

American Petroleum Institute
12220 L Street, Northwest,
Washington, D. C. 20005
(202) 682-8000

“Criteria for a Recommended Standard...Working in Confined Space”

The National Institute for Occupational Safety and Health
Superintendent of Documents
U.S. Government Printing Office
Washington, D. C. 20402

“Flammable and Combustible Liquids Code”
NFPA 30

“Code for Motor Fuel Dispensing Facilities and Repair Garages”
NFAP 30A

National Fire Protection Association
1 Batterymarch Park
Quincy, MA 02169-7471

“29 Code of Federal Regulations (CFR) 1926 Subpart P – Excavations”

<http://www.osha.gov>

APPENDIX B
Underground Storage Tank Division Regional Office Contact
Information and Map Showing Parishes Covered by Regional
Offices

Southeast Regional Office (SERO)
201 Evans Road, Bldg. 4, Suite 420
New Orleans, LA 70123
(504) 736-7701
Fax (504) 736-7702

Northeast Regional Office (NERO)
1823 Hwy 546
West Monroe, LA 71292
(318) 362-5439
Fax (318) 362-5448

Bayou Lafourche Office (BLRO)
(BLRO is a sub-office of SERO)
110 Barataria Street
Lockport, LA 70374
(985) 532-6206
Fax (985) 532-9945

Kisatchie Central Office (KCRO)
(KCRO is a sub-office of NERO)
402 Rainbow Drive, Bldg 402
Pineville, LA 71360
(318) 487-5656
Fax (318) 487-5927

Capital Regional Office (CRO)
Attn: UST Division – Surveillance Process
P. O. Box 4313
Baton Rouge, LA 70821
(225) 219-3768
Fax (225) 325-8223

Northwest Regional Office (NWRO)
1525 Fairfield Avenue, Room 520
Shreveport, LA 71101
(318) 676-7476
Fax (318) 676-7573

Acadiana Regional Office (ARO)
111 New Center Drive
Lafayette, LA 70508
(337) 262-5584
Fax (337) 262-5593

Southwest Regional Office (SWRO)
1301 Gadwall St.
Lake Charles, LA 70615
(337) 491-2667
Fax (337) 491-2682

*Addresses are subject to change. Check the LDEQ website for current UST Division Regional Office addresses, phone numbers and contacts (www.deq.louisiana.gov).

APPENDIX B

Underground Storage Tank Division Regional Office Contact Information and Map Showing Parishes Covered by Regional Offices

LDEQ Regional Districts

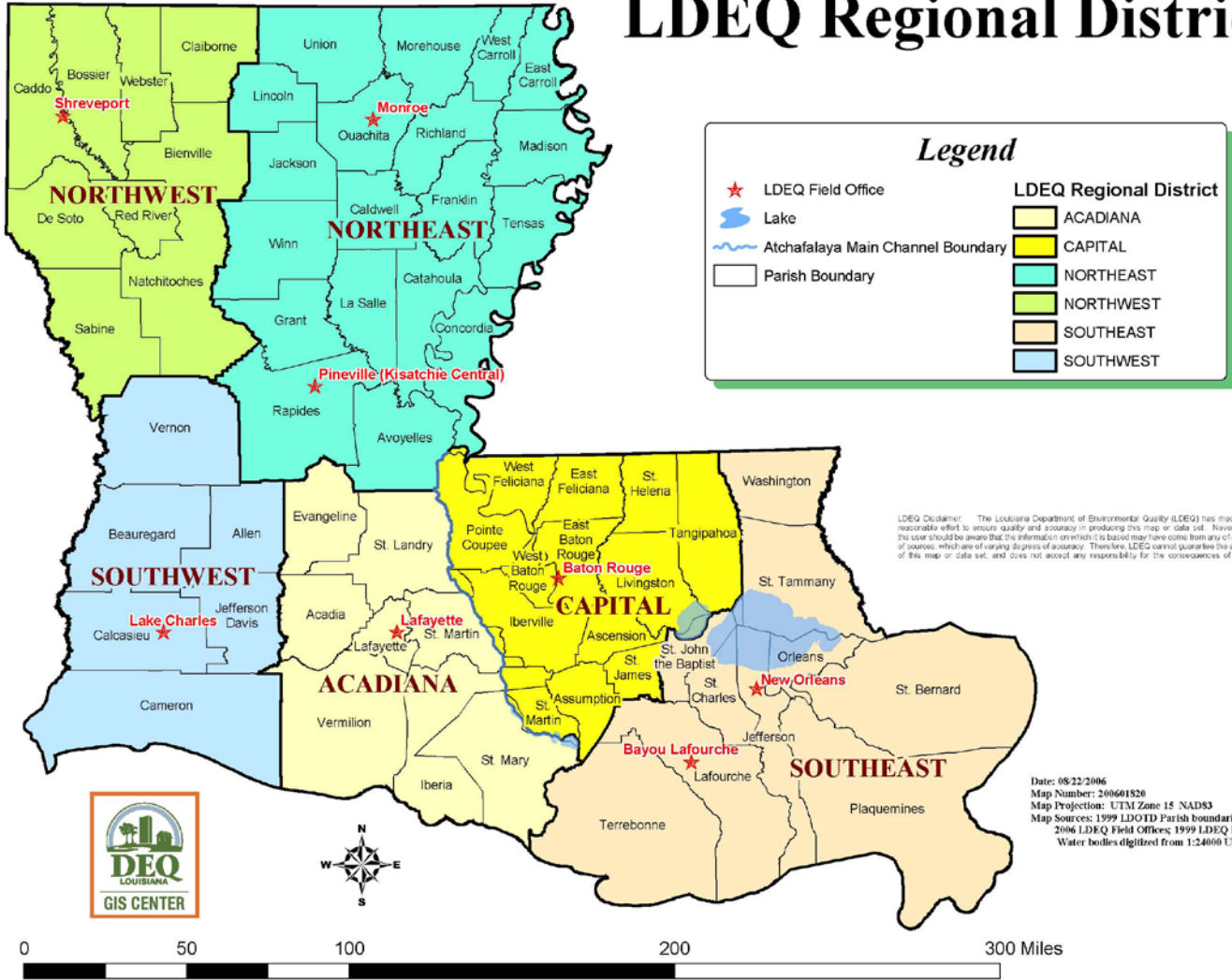

APPENDIX C

Notification of Intent to Perform a Closure or Change-in-Service to an Underground Storage Tank System Form

Please complete and return thirty (30) days prior to permanent UST system closure or change-in-service.

| Return: LDEQ- UNDERGROUND STORAGE TANKS DIVISION Appropriate Regional Office See attached mailing list or USTD Submittal info @ www.deq.louisiana.gov Questions: (225) 219-3181 | | DEQ Facility Number _____ DEQ AI Number _____ | | | | | | | | | | | | | | | | | | | | | | | | | | | | | | | | | | | | | | | | | | | | | | | |
|--|----------------------------------|---|-----------------------------|---------------------------|-----------------------------|-----------------------------|--|--|--|--|--|--|--|--|--|--|--|--|--|--|--|--|--|--|--|---------------------------|------------------------|-----------------------------|---------------------------|------------------------|-----------------------------|--|--|--|--|--|--|--|--|--|--|--|--|--|--|--|--|--|--|
| I. OWNERSHIP OF TANKS | | II. LOCATION OF TANKS | | | | | | | | | | | | | | | | | | | | | | | | | | | | | | | | | | | | | | | | | | | | | | | |
| IF OWNER'S ADDRESS CHANGED, PLEASE CHECK <input type="checkbox"/> | | IF SAME AS SECTION I. PLEASE CHECK <input type="checkbox"/> | | | | | | | | | | | | | | | | | | | | | | | | | | | | | | | | | | | | | | | | | | | | | | | |
| OWNER NAME (CORPORATION/INDIVIDUAL, ETC.) _____ | | FACILITY NAME OR COMPANY SITE IDENTIFIER _____ | | | | | | | | | | | | | | | | | | | | | | | | | | | | | | | | | | | | | | | | | | | | | | | |
| MAILING ADDRESS _____ | | STREET ADDRESS (P. O. BOX NOT ACCEPTABLE) _____ | | | | | | | | | | | | | | | | | | | | | | | | | | | | | | | | | | | | | | | | | | | | | | | |
| CITY _____ STATE _____ ZIP _____ | CITY _____ STATE _____ ZIP _____ | PARISH/COUNTY _____ | PARISH _____ | | | | | | | | | | | | | | | | | | | | | | | | | | | | | | | | | | | | | | | | | | | | | | |
| () TELEPHONE (INCLUDE AREA CODE) _____ | | () TELEPHONE (INCLUDE AREA CODE) _____ | | | | | | | | | | | | | | | | | | | | | | | | | | | | | | | | | | | | | | | | | | | | | | | |
| NAME OF CONTACT _____ | | CONTACT PERSON AT THIS LOCATION _____ | | | | | | | | | | | | | | | | | | | | | | | | | | | | | | | | | | | | | | | | | | | | | | | |
| III. TANK INFORMATION | | | | | | | | | | | | | | | | | | | | | | | | | | | | | | | | | | | | | | | | | | | | | | | | | |
| DATE SCHEDULED FOR CLOSURE/REMOVAL OR CHANGE-IN-SERVICE _____ | | | | | | | | | | | | | | | | | | | | | | | | | | | | | | | | | | | | | | | | | | | | | | | | | |
| <table border="1" style="width: 100%; border-collapse: collapse;"> <thead> <tr> <th style="width: 15%;">DEQ ASSIGNED TANK NUMBERS</th> <th style="width: 20%;">SIZE OF TANK (GALLONS)</th> <th style="width: 20%;">PRODUCT LAST STORED IN TANK</th> <th style="width: 15%;">DEQ ASSIGNED TANK NUMBERS</th> <th style="width: 20%;">SIZE OF TANK (GALLONS)</th> <th style="width: 20%;">PRODUCT LAST STORED IN TANK</th> </tr> </thead> <tbody> <tr><td> </td><td> </td><td> </td><td> </td><td> </td><td> </td></tr> <tr><td> </td><td> </td><td> </td><td> </td><td> </td><td> </td></tr> <tr><td> </td><td> </td><td> </td><td> </td><td> </td><td> </td></tr> </tbody> </table> | DEQ ASSIGNED TANK NUMBERS | SIZE OF TANK (GALLONS) | PRODUCT LAST STORED IN TANK | DEQ ASSIGNED TANK NUMBERS | SIZE OF TANK (GALLONS) | PRODUCT LAST STORED IN TANK | | | | | | | | | | | | | | | | | | | <table border="1" style="width: 100%; border-collapse: collapse;"> <thead> <tr> <th style="width: 15%;">DEQ ASSIGNED TANK NUMBERS</th> <th style="width: 20%;">SIZE OF TANK (GALLONS)</th> <th style="width: 20%;">PRODUCT LAST STORED IN TANK</th> <th style="width: 15%;">DEQ ASSIGNED TANK NUMBERS</th> <th style="width: 20%;">SIZE OF TANK (GALLONS)</th> <th style="width: 20%;">PRODUCT LAST STORED IN TANK</th> </tr> </thead> <tbody> <tr><td> </td><td> </td><td> </td><td> </td><td> </td><td> </td></tr> <tr><td> </td><td> </td><td> </td><td> </td><td> </td><td> </td></tr> <tr><td> </td><td> </td><td> </td><td> </td><td> </td><td> </td></tr> </tbody> </table> | DEQ ASSIGNED TANK NUMBERS | SIZE OF TANK (GALLONS) | PRODUCT LAST STORED IN TANK | DEQ ASSIGNED TANK NUMBERS | SIZE OF TANK (GALLONS) | PRODUCT LAST STORED IN TANK | | | | | | | | | | | | | | | | | | |
| DEQ ASSIGNED TANK NUMBERS | SIZE OF TANK (GALLONS) | PRODUCT LAST STORED IN TANK | DEQ ASSIGNED TANK NUMBERS | SIZE OF TANK (GALLONS) | PRODUCT LAST STORED IN TANK | | | | | | | | | | | | | | | | | | | | | | | | | | | | | | | | | | | | | | | | | | | | |
| | | | | | | | | | | | | | | | | | | | | | | | | | | | | | | | | | | | | | | | | | | | | | | | | | |
| | | | | | | | | | | | | | | | | | | | | | | | | | | | | | | | | | | | | | | | | | | | | | | | | | |
| | | | | | | | | | | | | | | | | | | | | | | | | | | | | | | | | | | | | | | | | | | | | | | | | | |
| DEQ ASSIGNED TANK NUMBERS | SIZE OF TANK (GALLONS) | PRODUCT LAST STORED IN TANK | DEQ ASSIGNED TANK NUMBERS | SIZE OF TANK (GALLONS) | PRODUCT LAST STORED IN TANK | | | | | | | | | | | | | | | | | | | | | | | | | | | | | | | | | | | | | | | | | | | | |
| | | | | | | | | | | | | | | | | | | | | | | | | | | | | | | | | | | | | | | | | | | | | | | | | | |
| | | | | | | | | | | | | | | | | | | | | | | | | | | | | | | | | | | | | | | | | | | | | | | | | | |
| | | | | | | | | | | | | | | | | | | | | | | | | | | | | | | | | | | | | | | | | | | | | | | | | | |
| ATTACH CONTINUATION SHEETS IF NECESSARY | | | | | | | | | | | | | | | | | | | | | | | | | | | | | | | | | | | | | | | | | | | | | | | | | |
| IV. TANK CLOSURE INFORMATION | | | | | | | | | | | | | | | | | | | | | | | | | | | | | | | | | | | | | | | | | | | | | | | | | |
| A. If the tank(s) are to be closed in place, indicate cleaning method and the type of fill material to be used: _____ | | | | | | | | | | | | | | | | | | | | | | | | | | | | | | | | | | | | | | | | | | | | | | | | | |
| B. Name of UST Certified Worker _____ Certificate No. _____ | | | | | | | | | | | | | | | | | | | | | | | | | | | | | | | | | | | | | | | | | | | | | | | | | |
| C. Name of Contracting Company _____ | | | | | | | | | | | | | | | | | | | | | | | | | | | | | | | | | | | | | | | | | | | | | | | | | |
| D. Name of laboratory to conduct sample analysis _____ | | | | | | | | | | | | | | | | | | | | | | | | | | | | | | | | | | | | | | | | | | | | | | | | | |
| FORMS THAT INCLUDE "TO BE DETERMINED" OR "UNKNOWN" AS A RESPONSE WILL BE REJECTED | | | | | | | | | | | | | | | | | | | | | | | | | | | | | | | | | | | | | | | | | | | | | | | | | |
| V. CERTIFICATION | | | | | | | | | | | | | | | | | | | | | | | | | | | | | | | | | | | | | | | | | | | | | | | | | |
| I certify that the above information is correct to the best of my knowledge and that the appropriate UST Regional Office will be contacted seven days prior to performing the UST system closure or change-in-service. I agree if closure or change-in-service of the UST system does not begin within 90 days after DEQ's approval, that this form becomes invalid. I also agree to submit the following information within 60 days after closure/change-in-service of the UST system: | | | | | | | | | | | | | | | | | | | | | | | | | | | | | | | | | | | | | | | | | | | | | | | | | |
| (1) the 'UST Closure/Assessment Form' (UST-SURV-02); (2) two copies of a site drawing to include the information required by the "Underground Storage Tank Closure/Change-in-Service Assessment Guidelines"; (3) two copies of analytical results with chain-of-custody documents; and (4) two copies of all manifests, bills of lading or receipts for the disposition of tank(s), tank contents, soil and waters. | | | | | | | | | | | | | | | | | | | | | | | | | | | | | | | | | | | | | | | | | | | | | | | | | |
| PRINT OR TYPE OWNER'S NAME _____ | OWNER'S SIGNATURE _____ | DATE _____ | | | | | | | | | | | | | | | | | | | | | | | | | | | | | | | | | | | | | | | | | | | | | | | |
| FORMS THAT DO NOT INCLUDE THE OWNER'S SIGNATURE WILL BE REJECTED | | | | | | | | | | | | | | | | | | | | | | | | | | | | | | | | | | | | | | | | | | | | | | | | | |

SPECIAL DOCUMENT

LDEQ RESPONSE - DO NOT WRITE BELOW THIS LINE

DEQ AI No. _____
 Approved for the indicated activity.
 Rejected for the following reason:

DEQ records indicate that the contractor you have selected is not a UST worker certified by DEQ for closure. You must select, from the enclosed list, a contractor that is a certified UST worker.
 DEQ records indicate that the UST system has not been registered. You must complete the attached registration form and return it to this office **IMMEDIATELY**.

The noted highlighted section(s) of this form must be completed in order for LDEQ to process.
 This form has not been signed by the owner. Please resubmit with the required signature.

Signature of LDEQ Representative _____ Telephone No. - _____ Date / / _____

APPENDIX D
Seven-Day Notification – Fax Transmittal Form

FAX TRANSMITTAL
SEVEN DAY PRIOR NOTICE TO PERFORMING CLOSURE OR
CHANGE-IN-SERVICE TO AN UNDERGROUND STORAGE TANK

TO: Fax is to be transmitted to the following UST Division Regional Office:

- | | |
|--|--|
| <input type="checkbox"/> Southeast Regional Office (504) 736-7702 | <input type="checkbox"/> Southwest Regional Office (337) 491-2682 |
| <input type="checkbox"/> Capital Regional Office (225) 219-3768 | <input type="checkbox"/> Northwest Regional Office (318) 676-7573 |
| <input type="checkbox"/> Acadiana Regional Office (337) 262-5593 | <input type="checkbox"/> Northeast Regional Office (318) 362-5448 |
| <input type="checkbox"/> Bayou Lafourche Office (985) 532-9945 | <input type="checkbox"/> Kisatchie Central Office (318) 487-5927 |

FROM: Name of Person Providing Notice: _____
Company: _____
Telephone Number: (____) _____

SUBJECT: Seven-Day Notice Prior to Performing UST Closure or Change-in-Service

On ___/___/___ at _____ a.m. / p.m., I contacted the above-noted regional office to provide notification of a UST closure/change-in-service. As all regional personnel were in the field at the time of my call, I am transmitting this notice that closure or change-in-service will be conducted at the following site:

Facility Name: _____ Agency Interest Number: _____
Date/Estimated Time of Closure/Change-in-Service: ___/___/___ ____ a.m./p.m.
Site Physical Location: _____

A Notification of Intent to Perform a Closure or Change-in-Service to an Underground Storage Tank System form was submitted to the Underground Storage Tank Division at least 30 days prior to the date noted above.

I AGREE THAT CLOSURE/CHANGE-IN-SERVICE OF THE UST WILL NOT COMMENCE UNTIL I HAVE RECEIVED APPROVAL FROM THE REGIONAL OFFICE. Also, I will contact the regional office as soon as possible if rescheduling of the tank closure/change-in-service is necessary due to inclement weather.

Signature of Person Providing Notice

Date

Time
UST-ENF-05

APPENDIX E

Underground Storage Tank Closure/Assessment Form

Please complete and return within sixty (60) days after UST system closure or change-in-service

| | |
|--|--|
| Return to: LDEQ - UNDERGROUND STORAGE TANK DIVISION Appropriate Regional Office See attached mailing list or USTD Submittal information at www.deq.louisiana.gov Questions: (225) 219-3181 | DEQ Agency Interest Number _____ DEQ Facility ID Number _____ |
| I. OWNERSHIP OF TANKS | II. LOCATION OF TANKS |
| IF OWNER'S ADDRESS CHANGED, PLEASE CHECK <input type="checkbox"/> | IF SAME AS SECTION I. PLEASE CHECK <input type="checkbox"/> |
| OWNER NAME (CORPORATION/INDIVIDUAL, ETC.) _____ | FACILITY NAME OR COMPANY SITE IDENTIFIER _____ |
| MAILING ADDRESS _____ | STREET ADDRESS (P. O. BOX <u>NOT</u> ACCEPTABLE) _____ |
| CITY _____ STATE _____ ZIP _____ | CITY _____ STATE _____ ZIP _____ |
| PARISH/COUNTY _____ () | PARISH _____ () |
| TELEPHONE (INCLUDE AREA CODE) _____ | TELEPHONE (INCLUDE AREA CODE) _____ |
| NAME OF CONTACT PERSON _____ | CONTACT PERSON AT THIS LOCATION _____ |

| III. TANK INFORMATION (Attach Continuation Sheets if Necessary) | | | | | | |
|---|-------------------------|-----------------------------|--|--------------------------|--------------------------|--------------------------------------|
| DEQ ASSIGNED TANK NUMBERS | SIZE OF TANKS (GALLONS) | PRODUCT LAST STORED IN TANK | CHOOSE ONE PER TANK 1 = Removed 2 = Closed-in-Place 3 = Change-in-Service 1 4 = Removed & Replaced 2 | TANK PROPERLY LABELED? | | DATE OF CLOSURE OR CHANGE-IN-SERVICE |
| | | | | Yes | No | |
| | | | | <input type="checkbox"/> | <input type="checkbox"/> | |
| | | | | <input type="checkbox"/> | <input type="checkbox"/> | |
| | | | | <input type="checkbox"/> | <input type="checkbox"/> | |
| | | | | <input type="checkbox"/> | <input type="checkbox"/> | |
| | | | | <input type="checkbox"/> | <input type="checkbox"/> | |

1 - Indicate the non-regulated substance to be stored in the tank.
 2 - A registration form addressing the replacement tank must be completed.
 3 - Highest reading recorded just before tank removed from excavation.
 4 - Lower Explosive Limit

| IV. TANK | V. TANK SLUDGES | VI. TANK WATERS/WASHWATERS |
|---|----------------------------------|--|
| A. Date cleaned _____ | A. Date disposed/recycled _____ | A. Date disposed/recycled _____ |
| B. Date disposed/recycled _____ | B. Volume removed (cu/yds) _____ | B. Volume removed (gals) _____ |
| C. Name of disposal site/recycling site _____ | C. Name of disposal site _____ | C. Name of disposal/recycling site _____ |

| VII. CONTAMINATED SOIL | VIII. CONTAMINATED GROUNDWATER |
|--|---|
| A. Date removed _____ | D. Date disposed _____ |
| B. Volume of soil removed (cu/yds) _____ | B. Volume of groundwater removed (gals) _____ |
| C. Name of disposal site _____ | C. Name of disposal site/recycler _____ |

| IX. CERTIFICATION | | | |
|--|---|-----------------------|------------|
| I certify under penalty of law that I have personally examined and am familiar with the information submitted in this and all attached documents, and that based on my inquiry of those individuals immediately responsible for obtaining the information, I believe that the submitted information is true, accurate, and complete. | | | |
| PRINT OR TYPE OWNER'S NAME _____ | OWNER'S SIGNATURE _____ | DATE _____ | |
| PRINT OR TYPE NAME OF CERTIFIED WORKER _____ | SIGNATURE OF CERTIFIED UST WORKER _____ | CERTIFICATE NO. _____ | DATE _____ |
| FORMS THAT DO NOT INCLUDE THE OWNER'S AND UST WORKER'S SIGNATURES WILL BE REJECTED. | | | |

LDEQ RESPONSE - DO NOT WRITE BELOW THIS LINE

UST system removed from database; no further action required at this time.
 Referred for remediation review.
 UST system removed from database; additional information required. _____

Signature of LDEQ Representative _____ Telephone No. - _____ Date / / _____ Supervisor's Initials _____

UST-SURV-02

*** INCOMPLETE FORMS MAY BE REJECTED ***

Revised 2/10

ORIGINAL DOCUMENT

APPENDIX F Sample Site Drawing

UST-ENF-06

Revised 5/01/10

Facility: _____ Agency Interest No.: _____
 Depth to Groundwater (if encountered): _____

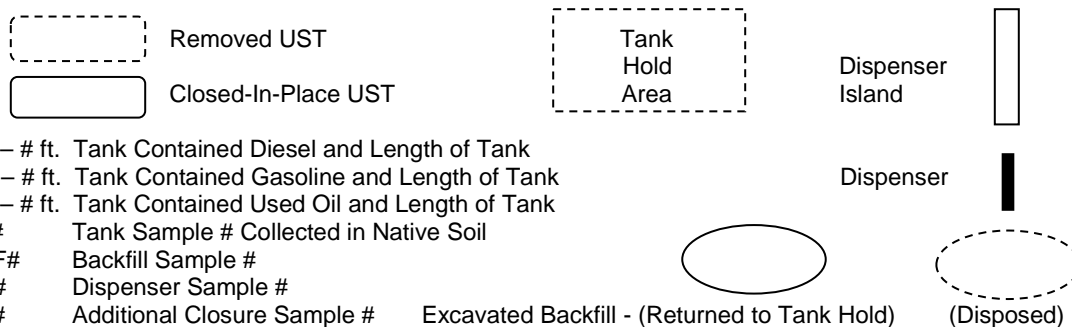
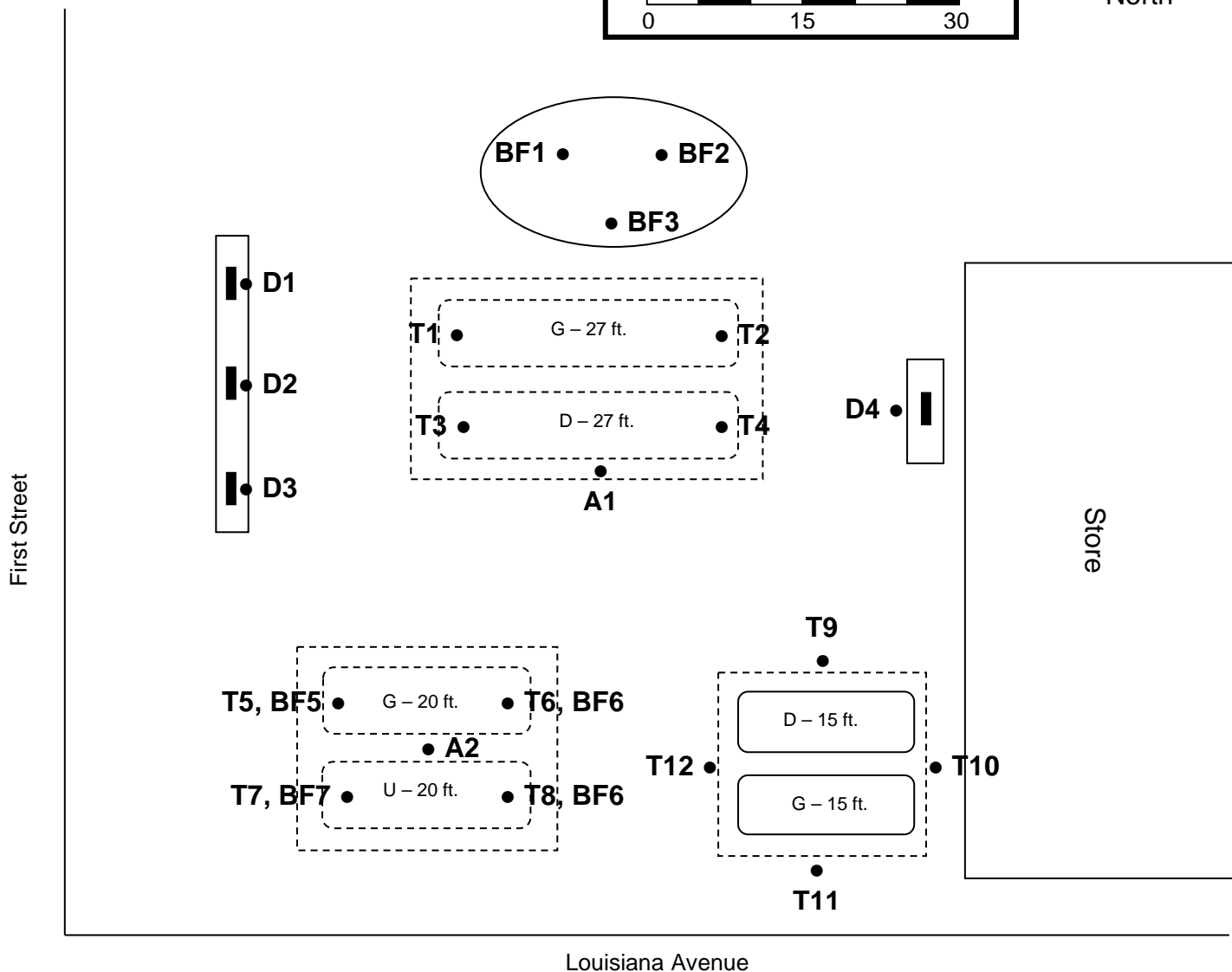

APPENDIX G Site Drawing Form

UST-ENF-06

Revised 05/01/10

Facility: _____ Agency Interest No.: _____
 Depth to Groundwater (if encountered): _____

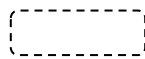
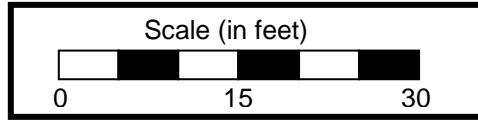

Removed UST

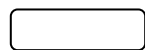

Closed-In-Place UST

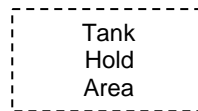

Tank
Hold
Area

Dispenser
Island

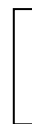

Dispenser



- D – # ft. Tank Contained Diesel and Length of Tank
- G – # ft. Tank Contained Gasoline and Length of Tank
- U – # ft. Tank Contained Used Oil and Length of Tank
- T# Tank Sample # Collected in Native Soil
- BF# Backfill Sample #
- D# Dispenser Sample #
- A# Additional Closure Sample #



Excavated Backfill - (Returned to Tank Hold)



(Disposed)

APPENDIX I
Conveyance Notification Form Letter

CONVEYANCE NOTIFICATION

(*Name of current property owner*) hereby notifies the public that the following described Area of Investigation (AOI), Louisiana Department of Environmental Quality (LDEQ) Agency Interest Number (*list AI number*), was closed with contaminant levels present that are acceptable for *{industrial/commercial use of the property || groundwater that is not connected to a on-site domestic water supply}* as described in LDEQ's Risk Evaluation/Corrective Action Program (RECAP), Section 2.17. In accordance with LAC 33:I., Chapter 13, if *{land use is to change from industrial to non-industrial || a domestic water supply well is to be installed}*, the responsible party shall notify the LDEQ within 30 days and the AOI shall be reevaluated to determine if conditions are appropriate for the proposed land use.

This site was closed in accordance with the Louisiana Administrative Code, Title 33:I., Chapter 13. Information regarding this site is available in the LDEQ public record and may be obtained by contacting the LDEQ Records Manager at (225) 219-3168. Inquiries regarding the contents of this site may be directed to (*name of person with knowledge of the contents of the AOI*) at (*address of person with knowledge of the content of the AOI*).

AOI Description:

(Provide the legal description of the property upon which the AOI is located. Also attach a scaled site plan showing the affected soil and/or groundwater zones and a table listing the maximum remaining contaminant concentrations in each medium.)

Signature of Person Filing Parish Record

Typed Name and Title of Person Filing Parish Record

Date

(A true copy of the document certified by the parish clerk of court must be sent to the Underground Storage Tanks Division – Regional Office of site location)

APPENDIX J UST Closure Checklist

- Submit the “Notification of Intent to Perform a Closure or Change-In-Service to an Underground Storage Tank System” form (UST-SURV-01) to the appropriate UST Division Regional Office at least 30 days prior to the UST closure or change-in-service.
- Notify any agencies as required such as local fire departments, local fire prevention bureaus and obtain any local permits as required.
- Notify the appropriate UST Division Regional Office by fax, email, or telephone at least 7 days prior to the scheduled date and time of the UST closure or change-in-service.
- Call Louisiana One Call (811 or 1-800-272-3020) at least 48 hours prior to any excavation activities and arrange for all underground lines and utilities to be located and marked.
- Conduct a site inspection prior to commencement of UST closure or change-in-service activities to observe site for any overhead obstructions or nearby buildings that may interfere with UST closure or change-in-service.
- On the day of and prior to conducting the UST closure or change-in-service activities review the Health and Safety Plan (HASP) and obtain signatures of all workers present.
- Locate UST system and prepare scaled site plan sketch (Note tank and line locations, tank sizes, product types, dispenser islands, buildings, streets, etc.).
- Identify and barricade sufficient work space for workers and equipment (50 feet from edge of excavation).
- Excavate to top of tank, drain and flush piping, cap piping ends if left in place. Remove drop tube, submerged pump if present, and any fittings from UST. Leave vent line in place.
- Leave the tank in the excavation during all cleaning and vapor freeing activities. The tank may be removed from the excavation only after the tank is clean and vapor free.
- Remove all product and residue from tank and lines by vacuum truck or explosion-proof pump.
- Remove vapors from tank by:
 - o **Purging**
 - Venturi Eductor Method - pulls air into the tank through the vent line, up the drop tube and out the Venturi eductor.
 - Diffused Air Blower Method - pushes compressed air into the tank through the opening with drop tube removed, through an air diffuser, and out the vent line.
 - Ground the equipment and tank. After purging take CGI readings at several openings and at different levels in tank until the readings are below 10% LEL.

APPENDIX J UST Closure Checklist

- **Inerting**
 - Dry Ice (CO₂) – use a minimum of approximately 1½ to 2 pounds per 100 gallons of tank capacity. Distribute evenly over the greatest possible area of the tank. All openings except the vent line are plugged. **Caution:** This is only an estimate amount of dry ice. The only way to determine if enough dry ice was used to make the atmosphere safe from ignition is to have less than 5% oxygen when measuring with an oxygen meter.
 - Nitrogen (N₂) – use approximately one 50 lb. bottle per 2500 gallons of tank capacity. All openings except the vent line are plugged.
 - Ground the equipment and tank. Do not apply more than 5 psig to the tank. After inerting take oxygen readings at several openings until the readings are below 6% to 7%.
- A purged or inerted tank can return to flammable status, so readings should be taken regularly during the entire time tanks are on site. Include areas lower than grade and in the immediate vicinity of the tank(s).
- Once the tank is vapor free, remove all purging or inerting equipment, and close all openings with threaded plugs. Disconnect the vent line. Close the vent opening with a threaded plug that has a 1/8" (API) or ¼" (NFPA) hole pre-drilled through it to allow tank to breathe in response to temperature changes.
- Lift tank from excavation with equipment capable of lifting tank (never drag or roll it). Set tank on trailer for transport.
- Properly label tank for transport as recommended by API.
- Obtain soil samples as described in the "Underground Storage Tank Closure/Change-In-Service Guidance Document". Place soil samples on ice, complete chain-of-custody, and transport/ship samples to LDEQ accredited laboratory for analysis.
- Submit the "Closure Assessment Form" (UST-SURV-02) and a "Closure Assessment Report" to the appropriate UST Division Regional Office at least 60 days following permanent closure or change-in-service.

This is intended as a checklist and does not provide instruction on every procedure for proper UST closure or change-in-service. It is the UST Certified Closure Contractor's responsibility to ensure all applicable rules, regulations, and recommended industry practices are followed during UST closure or change-in-service.

APPENDIX K
Sample Laboratory Analytical Results Table

| Sample ID | Date Collected | Constituent | Depth (Feet) | Concentration (mg/kg) | Soil Vapor Screening (ppmv) | SPLP (mg/L) |
|-----------|----------------|------------------|--------------|-----------------------|-----------------------------|-------------|
| T1 | 1/26/2009 | | 2 | | 5 | |
| T1 | 1/26/2009 | | 4 | | 8 | |
| T1 | 1/26/2009 | | 6 | | 15 | |
| T1 | 1/26/2009 | | 8 | | 20 | |
| T1 | 1/26/2009 | Benzene | 10 | 0.95 | 30 | |
| T1 | 1/26/2009 | Toluene | 10 | 15 | 30 | |
| T1 | 1/26/2009 | Ethylbenzene | 10 | 18 | 30 | |
| T1 | 1/26/2009 | Xylenes | 10 | 10 | 30 | |
| T1 | 1/26/2009 | MTBE | 10 | 0.75 | 30 | |
| T1 | 1/26/2009 | TPH-GRO | 10 | 150 | 30 | |
| T1 | 1/26/2009 | | 12 | | 15 | |
| | | | | | | |
| T2 | 1/26/2009 | | 2 | | 10 | |
| T2 | 1/26/2009 | | 4 | | 8 | |
| T2 | 1/26/2009 | | 6 | | 25 | |
| T2 | 1/26/2009 | | 8 | | 100 | |
| T2 | 1/26/2009 | Benzene | 10 | 5.1 | 500 | 0.08 |
| T2 | 1/26/2009 | Toluene | 10 | 35 | 500 | 4.1 |
| T2 | 1/26/2009 | Ethylbenzene | 10 | 50 | 500 | 0.8 |
| T2 | 1/26/2009 | Xylenes | 10 | 75 | 500 | 7.2 |
| T2 | 1/26/2009 | MTBE | 10 | 1.5 | 500 | 0.1 |
| T2 | 1/26/2009 | TPH-GRO | 10 | 1500 | 500 | |
| T2 | 1/26/2009 | Aliphatics C6-8 | 10 | 1250 | 500 | |
| T2 | 1/26/2009 | Aliphatics C8-10 | 10 | 150 | 500 | |
| T2 | 1/26/2009 | Aromatics C8-10 | 10 | 100 | 500 | 5.1 |
| T2 | 1/26/2009 | | 12 | | 75 | |
| | | | | | | |
| D1 | 1/26/2009 | Benzene | 3 | 0.3 | | 0.01 |
| D1 | 1/26/2009 | Toluene | 3 | 5 | | |
| D1 | 1/26/2009 | Ethylbenzene | 3 | 3 | | |
| D1 | 1/26/2009 | Xylenes | 3 | 7 | | |
| D1 | 1/26/2009 | MTBE | 3 | 0.01 | | |
| D1 | 1/26/2009 | TPH-GRO | 3 | 27 | | |
| | | | | | | |
| D2 | 1/26/2009 | Benzene | 3 | 0.04 | | |
| D2 | 1/26/2009 | Toluene | 3 | 10 | | |
| D2 | 1/26/2009 | Ethylbenzene | 3 | 7 | | |
| D2 | 1/26/2009 | Xylenes | 3 | 13 | | |
| D2 | 1/26/2009 | MTBE | 3 | 0.05 | | |
| D2 | 1/26/2009 | TPH-GRO | 3 | 15 | | |
| | | | | | | |
| | | | | | | |
| | | | | | | |

APPENDIX K
Sample Laboratory Analytical Results Table

| Sample ID | Date Collected | Constituent | Depth (Feet) | Concentration (mg/kg) | Soil Vapor Screening (ppmv) | SPLP (mg/L) |
|-----------|----------------|------------------------|--------------|-----------------------|-----------------------------|-------------|
| T3 | 1/26/2009 | TPH-DRO | 10 | 52 | | |
| T4 | 1/26/2009 | TPH-DRO | 10 | 1120 | | |
| T4 | 1/26/2009 | Aliphatics C10-12 | 10 | 100 | | |
| T4 | 1/26/2009 | Aliphatics C12-16 | 10 | 80 | | |
| T4 | 1/26/2009 | Aliphatics C16-35 | 10 | 620 | | |
| T4 | 1/26/2009 | Aromatics C10-12 | 10 | 110 | | 4.6 |
| T4 | 1/26/2009 | Aromatics C12-16 | 10 | 110 | | |
| T4 | 1/26/2009 | Aromatics C16-21 | 10 | 100 | | |
| T4 | 1/26/2009 | Acenaphthene | 10 | 16 | | |
| T4 | 1/26/2009 | Acenaphthylene | 10 | 4.0 | | |
| T4 | 1/26/2009 | Anthracene | 10 | 3.0 | | |
| T4 | 1/26/2009 | Benz(a)anthracene | 10 | 0.3 | | |
| T4 | 1/26/2009 | Benzo(a)pyrene | 10 | 0.3 | | |
| T4 | 1/26/2009 | Benzo(b)fluoranthene | 10 | 0.3 | | |
| T4 | 1/26/2009 | Benzo(k)fluoranthene | 10 | 0.3 | | |
| T4 | 1/26/2009 | Chrysene | 10 | 5.1 | | |
| T4 | 1/26/2009 | Dibenz(a,h)anthracene | 10 | 0.3 | | |
| T4 | 1/26/2009 | Fluoranthene | 10 | 26.1 | | |
| T4 | 1/26/2009 | Fluorene | 10 | 10.2 | | |
| T4 | 1/26/2009 | Indeno(1,2,3-cd)pyrene | 10 | 0.3 | | |
| T4 | 1/26/2009 | Methylnaphthalene,2- | 10 | 2.8 | | 0.06 |
| T4 | 1/26/2009 | Naphthalene | 10 | 5.3 | | 0.12 |
| T4 | 1/26/2009 | Phenanthrene | 10 | 710 | | 21.0 |
| T4 | 1/26/2009 | Pyrene | 10 | 17 | | |
| D3 | 1/26/2009 | TPH-DRO | 3 | 21.0 | | 0.01 |
| D4 | 1/26/2009 | TPH-DRO | 3 | 51.7 | | |
| D4 | 1/26/2009 | Acenaphthene | 3 | 2 | | |
| D4 | 1/26/2009 | Acenaphthylene | 3 | 3 | | |
| D4 | 1/26/2009 | Anthracene | 3 | 0.01 | | |
| D4 | 1/26/2009 | Benz(a)anthracene | 3 | 3 | | |
| D4 | 1/26/2009 | Benzo(a)pyrene | 3 | 0.3 | | |
| D4 | 1/26/2009 | Benzo(b)fluoranthene | 3 | 0.3 | | |
| D4 | 1/26/2009 | Benzo(k)fluoranthene | 3 | 0.3 | | |
| D4 | 1/26/2009 | Chrysene | 3 | 2 | | |
| D4 | 1/26/2009 | Dibenz(a,h)anthracene | 3 | 0.3 | | |
| D4 | 1/26/2009 | Fluoranthene | 3 | 9 | | |
| D4 | 1/26/2009 | Fluorene | 3 | 3 | | |
| D4 | 1/26/2009 | Indeno(1,2,3-cd)pyrene | 3 | 0.3 | | |
| D4 | 1/26/2009 | Methylnaphthalene,2- | 3 | 0.3 | | |
| D4 | 1/26/2009 | Naphthalene | 3 | 0.3 | | |
| D4 | 1/26/2009 | Phenanthrene | 3 | 10 | | |
| D4 | 1/26/2009 | Pyrene | 3 | 10 | | |

APPENDIX L
List of Industrial Solid Waste Facilities

| Facility Name | Contact | Address | Phone | Parish | Owner/Operator |
|--|-----------------|---|--|-----------------|--------------------------|
| Coast Guard Rd. Landfill | Kevin Guidry | P.O. Drawer 647, Venice, LA 7009 | 504-534-7886 | Plaquemines | Tidewater Landfill, Inc. |
| Colonial Landfill | Matt Robillard | P.O. Box 605, Sorrento, LA 70778 | 225-771-1212 225-675-8021 | Ascension | BFI |
| White Oaks | Bill Hay | P.O. Box 13355, Monroe, LA 71207 | 318-343-2026 | Ouachita | CWI |
| DeSoto Parish Landfill (Mundy) | Bill Smith | P.O. Box 898, Mansfield, LA 71052 | 318-872-2500 318-872-0739 318-872-2131 | DeSoto | Parish |
| East Baton Rouge North Landfill | Jorge Ferrer | P.O. Box 1471, Baton Rouge, LA 70821 | 225-389-5476 225-389-5245 225-389-4813 | E. Baton Rouge | Parish/BFI |
| Jefferson Davis Parish Landfill | Daniel Hylton | P.O. Box 1207, Jennings, LA 70546 | 337-734-4135 | Jefferson Davis | Parish/BFI |
| Jefferson Parish Landfill | Marnie Winter | 5800 Hwy 90, Avondale, LA 70094 | 504-436-0152 | Jefferson | Parish/WM |
| LaSalle/Grant Parish landfill | Dorsel Cobb | P.O. Box 1180, Jena, LA 71342-1180 | 318-992-5571 | LaSalle | Parish/IESI |
| Magnolia Landfill | Gabe Landry | P.O. Box 13467, Monroe, LA 71213 | 318-343-5636 | Ouachita | WM |
| Reliable Landfill LLC | David Mason | P.O. Box 576, Livonia, LA 70755 | 225-665-8225 225-637-3564 | Pointe Coupee | WM |
| River Birch Landfill | A.J. Ward, Jr. | P.O. Box 1938, Gretna, LA 70054 | 504-364-1140 | Jefferson | River Birch, Inc. |
| Sabine Parish Landfill | Pete Chreene | P.O. Box 507, Many, LA 71458 | 318-256-6361 | Sabine | IESI |
| St. Mary Parish Landfill (Harold Landry) | Norris Crappell | P.O. Box 251, Berwick, LA 70342 | 985-385-4531 | St. Mary | Parish |
| Tensas Parish Landfill | John Wynn | P.O. Box 598, St. Joseph, LA 71366 | 318-766-9219 | Tensas | IESI |
| Timberlane Landfill | Phil Smith | 2301 Eagle Pkwy. Ste. 200, Fort Worth, TX 76177 | 817-632-4000 | Allen | IESI |
| Webster Parish Landfill | Dan Frazier | P.O. Box 389, Minden, LA 71058-0389 | 318-377-9193 | Webster | Parish/WM |
| Woodside Landfill and Recycling Center | David Mason | 29375 Woodside Dr., Walker, LA 70785 | 225-665-8225 | Livingston | WM |

APPENDIX L
List of Industrial Solid Waste Facilities

| | | | | | |
|---------------------------|------------------|---|------------------------------|-------|---------------------------|
| Woolworth Rd. Landfill | Fred Williams | P.O. Box 31109, Shreveport, LA 71130 | 318-673-6300 318-925-3500 | Caddo | City of Shreveport/BFI |
|---------------------------|------------------|---|------------------------------|-------|---------------------------|

| Constituents | CAS # | A | B | C | D | E | F |
|--------------------------------|-----------|---------------------------------|---------------------------------------|-----------------------------------|------------------------------------|------------------------------------|------------------------|
| | | Limiting Soil Standards (mg/kg) | Non-Industrial Soil Standards (mg/kg) | Industrial Soil Standards (mg/kg) | Soil/Groundwater Standards (mg/kg) | Groundwater Standards (GW1) (mg/L) | SPLP (GW1 x 20) (mg/L) |
| Petroleum Constituents: | | | | | | | |
| Benzene | 71-43-2 | 0.051 | 1.5 | 3.1 | 0.051 | 0.005 | 0.1 |
| Toluene | 108-88-3 | 20 | 68 | 470 | 20 | 1.0 | 20 |
| Ethyl benzene | 100-41-4 | 19 | 160 | 230 | 19 | 0.7 | 14 |
| Xylene(mixed) | 1330-20-7 | 18 | 18 | 120 | 150 | 10 | 200 |
| MTBE (methyl tert-butyl ether) | 1634-04-4 | 0.077 | 650 | 4700 | 0.077 | 0.020 | 0.4 |
| TPH-GRO | NA | 65 | 65 | 510 | 65 | 0.34 | 6.8 |
| TPH-DRO | NA | 65 | 65 | 510 | 65 | 0.34 | 6.8 |
| TPH-ORO | NA | 180 | 180 | 2500 | 10000 | 1.1 | 22 |
| Aliphatics C6-C8 | NA | 1200 | 1200 | 8000 | 10000 | 32 | 640 |
| Aliphatics >C8-C10 | NA | 120 | 120 | 880 | 5300 | 1.3 | 26 |
| Aliphatics >C10-C12 | NA | 230 | 230 | 2000 | 10000 | 1.4 | 28 |
| Aliphatics >C12-C16 | NA | 370 | 370 | 3800 | 10000 | 1.4 | 28 |
| Aliphatics >C16-C35 | NA | 7100 | 7100 | 10000 | 10000 | 73 | 1460 |
| Aromatics >C8-C10 | NA | 65 | 65 | 510 | 65 | 0.34 | 6.8 |
| Aromatics >C10-C12 | NA | 100 | 120 | 1100 | 100 | 0.34 | 6.8 |
| Aromatics >C12-C16 | NA | 180 | 180 | 2100 | 200 | 0.34 | 6.8 |
| Aromatics >C16-C21 | NA | 150 | 150 | 1700 | 2100 | 1.1 | 22 |
| Aromatics >C21-C35 | NA | 180 | 180 | 2500 | 10000 | 1.1 | 22 |

| | | | | | | | |
|---------------------------|-------------|-----|-------|--------|------|-------|------|
| Total Metals: | | | | | | | |
| Arsenic | 7440-38-2 | 12 | 12 | 12 | 100 | 0.01 | 0.2 |
| Barium | 7440-39-3 | 550 | 550 | 14000 | 2000 | 2 | 40 |
| Cadmium | 7440-43-9 | 3.9 | 3.9 | 100 | 20 | 0.005 | 0.1 |
| Chromium(III) | 16065-83-1 | 100 | 12000 | 310000 | 100 | 0.1 | 2 |
| Chromium(VI) ¹ | 18540-29-97 | 23 | 23 | 610 | 100 | 0.1 | 2 |
| Lead (inorganic) | 7439-92-1 | 100 | 400 | 1400 | 100 | 0.015 | 0.3 |
| Mercury (inorganic) | 7487-94-7 | 2.3 | 2.3 | 61 | 4 | 0.002 | 0.04 |
| Selenium | 7782-49-2 | 20 | 39 | 1000 | 20 | 0.05 | 1.0 |
| Silver | 7440-22-4 | 39 | 39 | 1000 | 100 | 0.18 | 3.6 |

| | | | | | | | |
|---|----------|------|------|-------|--------|--------|-------|
| Polynuclear Aromatic Hydrocarbons (PAH): | | | | | | | |
| Acenaphthene | 83-32-9 | 220 | 370 | 6100 | 220 | 0.37 | 7.4 |
| Acenaphthylene | 208-96-8 | 88 | 350 | 5100 | 88 | 0.37 | 7.4 |
| Anthracene | 120-12-7 | 120 | 2200 | 48000 | 120 | 1.80 | 36 |
| Benz(a)anthracene | 56-55-3 | 0.62 | 0.62 | 2.90 | 330.00 | 0.0078 | 0.156 |
| Benzo(a)pyrene | 50-32-8 | 0.33 | 0.33 | 0.33 | 23.00 | 0.0002 | 0.004 |
| Benzo(b)fluoranthene | 205-99-2 | 0.62 | 0.62 | 2.90 | 220.00 | 0.0048 | 0.096 |
| Benzo(k)fluoranthene | 207-08-9 | 6.2 | 6.2 | 29 | 120 | 0.0025 | 0.050 |
| Chrysene | 218-01-9 | 62 | 62 | 290 | 76 | 0.0091 | 0.182 |
| Dibenz(a,h)anthracene | 53-70-3 | 0.33 | 0.33 | 0.33 | 540.00 | 0.0025 | 0.050 |
| Fluoranthene | 206-44-0 | 220 | 220 | 2900 | 1200 | 1.50 | 30 |
| Fluorene | 86-73-7 | 230 | 280 | 5400 | 230 | 0.24 | 4.8 |
| Indeno(1,2,3-cd)pyrene | 193-39-5 | 0.62 | 0.62 | 2.90 | 9.20 | 0.0037 | 0.074 |

Appendix M UST Soil Screening Standards

| | | | | | | | |
|----------------------|----------|------------|------|-------|------|--------|-------|
| Methylnaphthalene,2- | 91-57-6 | 1.7 | 22.0 | 170.0 | 1.7 | 0.0062 | 0.124 |
| Naphthalene | 91-20-3 | 1.5 | 6.2 | 43.0 | 1.5 | 0.01 | 0.2 |
| Phenanthrene | 85-01-8 | 660 | 2100 | 43000 | 660 | 1.80 | 36 |
| Pyrene | 129-00-0 | 230 | 230 | 5600 | 1100 | 0.18 | 3.6 |

¹ If chromium is not speciated, evaluate total chromium using chromium (VI).

Adapted from LDEQ RECAP (October 20, 2003)