

Bid Number 50-00142748

Two Year Contract to Perform Guardrail Maintenance (Removal, Installation and Repair) for the Jefferson Parish Department of Public Works – Streets and all Jefferson Parish Agencies and Municipalities

Bid Due: AUGUST 15, 2023 at 2:00 pm

ATTENTION VENDORS!!!

Please review all pages and respond accordingly, complying with all provisions in the technical specifications and Jefferson Parish Instructions for Bidders and General Terms and Conditions. All bids must be received on the Purchasing Department's eProcurement site by the bid due date and time.

**Jefferson Parish Purchasing Department
200 Derbigny Street
General Government Building, Suite 4400
Gretna, LA 70053
Buyer Name: Donna M Evans, Buyer II
Buyer Email: DMEVANS@jeffparish.net
Buyer Phone: 504-364-2691**

DATE: 7/12/2023
BID NO.: 50-00142748

INVITATION TO BID
THIS IS NOT AN ORDER

Page: 1

JEFFERSON PARISH

PURCHASING DEPARTMENT
P.O. BOX 9
GRETNA, LA. 70054-0009
504-364-2678

BUYER: DMEVANS@jeffparish.net

BIDS WILL BE RECEIVED ONLINE VIA WWW.JEFFPARISHBIDS.NET UNTIL 2:00 PM, 8/15/2023 AND PUBLICLY OPENED THEREAFTER IN THE WEST BANK PURCHASING DEPT, SUITE 4400, JEFFERSON PARISH GENERAL GOVERNMENT BUILDING, 200 DERBIGNY STREET, GRETNA, LA 70053. At no charge, bidders are to submit via Jefferson Parish's electronic procurement page by visiting www.jeffparishbids.net to register for this free site. Additional instructions are included in the text box highlighting electronic procurement.

LATE BIDS WILL NOT BE ACCEPTED

NOTE: ONLY BIDS WRITTEN IN INK OR TYPEWRITTEN, AND PROPERLY SIGNED BY A MEMBER OF THE FIRM OR AUTHORIZED REPRESENTATIVE, WILL BE ACCEPTED. PENCIL AND/OR PHOTOSTATIC FIGURES OR SIGNATURES SHALL RESULT IN BID REJECTION. HOWEVER, ELECTRONIC SIGNATURES AS DEFINED IN LSA - R.S. 9:2620(8) ARE ACCEPTABLE. SIGNATURE MUST BE A SECURED DIGITAL SIGNATURE.

INSTRUCTIONS FOR BIDDERS AND GENERAL CONDITIONS

THE FOLLOWING INSTRUCTIONS APPLY TO ALL BIDS

All bids submitted are subject to these instructions and general conditions and any special conditions and specifications contained herein, all of which are made part of this bid proposal reference. By submitting a bid, vendor agrees to comply with all provisions of Louisiana Law as well be in compliance with the Jefferson Parish Code of Ordinances, Louisiana Code of Ethics, applicable Jefferson Parish ethical standards and Jefferson Parish Resolution No. 113646 and/or Resolution No. 113647.

Jefferson Parish adheres to the Louisiana Code of Governmental Ethics, contained in Louisiana Revised Statutes Annotated, R.S. 42:1101, et seq. Vendor/Proposer by this submission, warrants that there are no "conflicts of interest" related to this procurement that would violate applicable Louisiana Law. Violation of the Louisiana Code of Governmental Ethics may result in rescission of contract, permit or licenses, and the imposition of fines and/or penalties, without contractual liability to the public in accordance with applicable law.

All vendors submitting bids should register as a Jefferson Parish vendor if not already yet registered. Registration forms may be downloaded from <http://purchasing.jeffparish.net> and by clicking on Vendor Information. Current W-9 forms with respective Tax Identification numbers and vendor applications may be submitted at any time; however, if your company is not registered and/or a current W-9 form is not on file, vendor registration is mandatory. Vendors may experience a delay in payment if your company is not a registered vendor with Jefferson Parish.

All quotations shall be based on F.O.B. Agency warehouse or job site, anywhere within the Parish as designated by the Purchasing Department. This provision does not apply to public works projects

JEFFERSON PARISH requires all products to be new (current) and all work must be performed according to standard practices for the project. Unless otherwise specified, no aftermarket parts will be accepted. Unless otherwise specified, all workmanship and materials must have at least one (1) year guaranty, in writing, from the date of delivery and/or acceptance of the project. Any deviations or alterations from the specifications must be indicated and/or supporting documentation supplied with bid submission.

Bidders should submit all questions in writing via email to the buyer's email address as indicated above, no later than Five (5) working days prior to the bid opening. Bid numbers should be mentioned in all requests. If submitting online, vendors may send questions via the E-Procurement site no later than Five (5) working days prior to the bid opening.

If this bid requires a pre-bid conference (see Additional Requirements section), bidders are advised that such conference will be held to allow bidders the opportunity to identify any discrepancies in the bid specifications and seek further clarification regarding instructions. The Purchasing Department will issue a written response to bidders' questions in the form of an Addendum. Please note that all official communication will be expressed in the form of an addendum.

Visit our website at [HTTP://PURCHASING.JEFFPARISH.NET](http://PURCHASING.JEFFPARISH.NET)

All formal Addenda require written acknowledgement on the bid form by the bidder. Failure to acknowledge an Addendum on the bid form shall cause the bid to be rejected. JEFFERSON PARISH reserves the right to award bid to next lowest responsive and responsible bidder in this event.

JEFFERSON PARISH will accept one price for each item unless otherwise indicated. Two or more prices for one item will result in bid rejection. Bidders are required to complete, sign and return the bid form and/or complete and return the associated line item pricing forms as indicated. Vendors must not alter the bid forms. Doing so will cause the bid to be rejected.

A corporate resolution or written evidence of the individual signing the bid having such authority must be submitted with the bid. Failure to comply will cause bid to be rejected. For corporate entities, such written evidence may be a printout of the Louisiana Secretary of State's website listing the signatory as an officer. Such printout shall be included with the bid submission. Bids submitted by Owners or Sole Proprietorships must include certification that he or she owns the entity for which the bid is signed. This documentation must be submitted with the bid. Failure to do so will result in bid rejection.

NOTE: A sample corporate resolution can be downloaded from our website <http://purchasing.jeffparish.net> or you may provide your own document. A sample certification of sole proprietorship can also be downloaded from our website <http://purchasing.jeffparish.net> or you may provide your own document.

INSTRUCTIONS FOR BIDDERS AND GENERAL CONDITIONS

A. AWARD OF CONTRACT: JEFFERSON PARISH reserves the right to award contracts or place orders on a lump sum or individual item basis, or such combination, as shall in its judgment be in the best interest of JEFFERSON PARISH. Every contract or order shall be awarded to the **LOWEST RESPONSIVE and RESPONSIBLE BIDDER**, taking into consideration the **CONFORMITY WITH THE SPECIFICATIONS** and the **DELIVERY AND/OR COMPLETION DATE**. **SPLIT AWARDS MADE TO SEVERAL VENDORS WILL ONLY BE GRANTED TO THOSE DEEMED RESPONSIVE AND RESPONSIBLE.**

All bid prices shall remain valid for 45 days. Jefferson Parish and the lowest responsive and responsible bidder(s) by mutual written consent may mutually agree to extend the deadline for award by one (1) or more extensions of thirty (30) calendar days.

PROTESTS: Only those vendors that submit bids in response to this solicitation may protest any element of the procurement, in writing to the Director of the Purchasing Department. Written protest must be received within 48 hours of the release of the bid tabulation by the Purchasing Department. After consultation, the Parish Attorney's Office will then respond to protests in writing. (For more information, please see Chapter 2, Article VII, Division 2, Sec. 2-914.1 of the Jefferson Parish Code of Ordinances.)

PREFERENCE: Unless federal funding is directly spent by Jefferson Parish for this purchase, preference is hereby given to materials, supplies, and provisions produced, manufactured or grown in Louisiana, quality being equal to articles offered by competitors outside the state. "LSA – R.S. 38:2251-2261"

B. USE OF BRAND NAMES AND STOCK NUMBERS: Where brand names and stock numbers are specified, it is for the purpose of establishing certain minimum standards of quality. Bids may be submitted for products of equal quality, provided brand names and stock numbers are specified. Complete product data may be required prior to award.

C. CANCELLATION OF CONTRACT: JEFFERSON PARISH reserves the right to cancel all or any part if not shipped promptly. No charges will be allowed for parking or cartage unless specified in quotation. The order must not be filled at a higher price than quoted. JEFFERSON PARISH reserves the right to cancel any contract at anytime and for any reason by issuing a THIRTY (30) day written notice to the contractor.

For good cause and as consideration for executing a contract with Jefferson Parish, vendor conveys, sells, assigns and transfers to Jefferson Parish or its assigns all rights, title and interest in and to all causes of action it may now or hereafter acquire under the antitrust laws of the United States and the State of Louisiana, relating to the particular good or services purchased or acquired by Jefferson Parish.

D. PRICES: Jefferson Parish is exempt from paying sales tax under LSA-R.S. 47:301 (8)(c). All prices for purchases by Jefferson Parish of supplies and materials shall be quoted in the unit of measure specified and unless otherwise specified, shall be exclusive of state and local taxes. For purchases of labor and materials, the Contractor shall not pay any state or local sales or use taxes on materials and equipment which are affixed and made part of the immovable property of the project or which permanently incorporated in the project (hereinafter referred to as "applicable materials and equipment"). All purchases of applicable materials or equipment shall be made by the contractor on behalf of and as the agent of Jefferson Parish (Owner), a political subdivision of the State of Louisiana. No state and local sales and use taxes are owned on applicable materials and equipment under the provisions of Act 1029 of the 1991 Regular Session - Louisiana Revised Statute 47:301(8)(c). Owner will furnish contractor a certificate form which certifies that Owner is not required to pay such state or local sales and use taxes, and contractor shall furnish a copy of such certificate to all vendors or suppliers of the applicable materials and equipment. The price quoted for work shall be stated in figures. In the event there is a difference in unit prices and totals, the unit price shall prevail.

Quantities listed are for bidding purposes only. Actual requirements may be more or less than quantities listed.

Bidders are not to exclude from participation in, deny the benefits of, or subject to discrimination under any program or activity, any person in the United States on the grounds of race, color, national origin, or sex; nor discriminate on the basis of age under the Age Discrimination Act of 1975, or with respect to an otherwise qualified handicapped individual as provided in Section 504 of the Rehabilitation Act of 1973, or on the basis of religion, except that any exemption from such prohibition against discrimination on the basis of religion as provided in the Civil Rights Act of 1964, or Title VI and VII of the Act of April 11, 1968, shall also apply. This assurance includes compliance with the administrative requirements of the Revenue Sharing final handicapped discrimination provisions contained in Section 51.55 (c), (d), (e), and (k)(5) of the Regulations. New construction or renovation projects must comply with Section 504 of the 1973 Rehabilitation Act, as amended, in accordance with the American National Standard Institute's specifications (ANSI A17.1-1961).

Jefferson Parish and its partners as the recipients of federal funds are fully committed to awarding a contract(s) to firm(s) that will provide high quality services and that are dedicated to diversity and to containing costs. Thus, Jefferson Parish strongly encourages the involvement of minority and/or woman-owned business enterprises (DBE's, including MBE's, WBE's and SBE's) to stimulate participation in procurement and assistance programs.

The purpose and intention of this invitation to bid is to afford all suppliers an equal opportunity to bid on all construction, maintenance, repair, operating supplies and/or equipment listed in this bid proposal. JEFFERSON PARISH WILL ACCEPT ONE BID ONLY FROM EACH VENDOR. Items bid must meet specifications.

Advertised bids will be tabulated and a copy of the tabulation will be forwarded to each responding bidder.

IN ACCORDANCE WITH STATE REGULATIONS JEFFERSON PARISH OFFERS ELECTRONIC PROCUREMENT TO ALL VENDORS

This electronic procurement system allows vendors the convenience of reviewing and submitting bids online. This is a secure site and authorized personnel have limited read access only. Bidders are to submit electronically using this free service; while the website accepts various file types, one single PDF file containing all appropriate and required bid documents is preferred. Bidders submitting uploaded images of bid responses are solely responsible for clarity. If uploaded images/documents are not legible, then bidder's submission will be rejected. Please note all requirements contained in this bid package for electronic bid submission.

Please visit our E-Procurement Page at www.jeffparishbids.net to register and view Jefferson Parish solicitations. For more information, please visit the Purchasing Department page at <http://purchasing.jeffparish.net>.

The general specifications for construction projects and the purchase of materials, services and/or supplies are those adopted by the JEFFERSON PARISH Council by Resolution No. 113646 or 113647 as amended. The general conditions adopted by this resolution shall be considered as much a part of this document as if they were written wholly herein. A copy may be obtained from the Office of the Parish Clerk, Suite 6700, Jefferson Parish General Government Building, 200 Derbigny Street, Gretna, LA 70053. You may also obtain a copy by visiting the Purchasing Department webpage at <http://purchasing.jeffparish.net> and clicking on Online Forms.

ADDITIONAL REQUIREMENTS FOR THIS BID

PLEASE MATCH THE NUMBERS PRINTED IN THIS BOX WITH THE CORRESPONDING INSTRUCTIONS BELOW.

2, 3, 4, 5, 6, 7, 10, 11, 12, 13, 14,17

**PRE-BID CONFERENCE TO BE HELD AT: GENERAL GOVERNMENT BUILDING, GRETN, LA
10:00 A.M. 200 DERBIGNY ST. SUITE 4400
ON 7/28/2023**

1. All bidders must attend the MANDATORY pre-bid conference and will be required to sign in and out as evidence of attendance. In accordance with LSA R.S. 38:2212(l), all prospective bidders shall be present at the beginning of the MANDATORY pre-bid conference and shall remain in attendance for the duration of the conference. Any prospective bidder who fails to attend the conference or remain for the duration shall be prohibited from submitting a bid for the project.
2. Attendance to this pre-bid conference is optional. However, failure to attend the pre-bid conference shall not relieve the bidder of responsibility for information discussed at the conference. Furthermore, failure to attend the pre-bid conference and inspection does not relieve the successful bidder from the necessity of furnishing materials or performing any work that may be required to complete the work in accordance with the specification with no additional cost to the owner.
3. Contractor must hold current applicable JEFFERSON PARISH licenses with the Department of Inspection and Code Enforcement. Contractor shall obtain any and all permits required by the JEFFERSON PARISH Department of Inspection and Code Enforcement. The contractor shall be responsible for the payment of these permits. All permits must be obtained prior to the start of the project. Contractor must also hold any and all applicable Federal and State licenses. Contractor shall be responsible for the payment of these permits and shall obtain them prior to the start of the project.

INSTRUCTIONS FOR BIDDERS AND GENERAL CONDITIONS

4. A LA State Contractor's License will be required in accordance with LSA R.S. 37-2150 et. seq. and such license number will be shown on the outside of the bid electronic envelope. Failure to comply will cause the bid to be rejected. When submitting the bid electronically, the license number must be entered in the appropriate field in the electronic procurement system. Failure to comply will cause the bid to be rejected.
5. It is the bidder's responsibility to visit the job site and evaluate the job before submitting a bid.
6. Job site must be clean and free of all litter and debris daily and upon completion of the contract. Passageways must be kept clean and free of material, equipment, and debris at all times. Flammable material must be removed from the job site daily because storage will not be permitted on the premises. Precaution must be exercised at all times to safeguard the welfare of JEFFERSON PARISH and the general public.
7. **PUBLIC WORKS BIDS:** All awards for public works in excess of \$5,000.00 will be reduced to a formal contract which shall be recorded at the contractor's expense with the Clerk of Court and Ex-Officio Recorder of Mortgages for the Parish of Jefferson. A price list of recordation costs may be obtained from the Clerk of Court and Ex-Officio Recorder of Mortgages for the Parish of Jefferson. All awards in excess of \$25,000.00 will require both a performance and a payment bond. Unless otherwise stated in the bid specifications, the performance bond requirements shall be 100% of the contract price. Unless otherwise state in the bid specifications, the payment bond requirements shall be 100% of the contract price. Both bonds shall be supplied at the signing of the contract.
8. **NON-PUBLIC WORKS BIDS:** A performance bond will be required for this bid. The amount of the bond will be 100% of the contract price unless otherwise indicated in the specifications. The performance bond shall be supplied at the signing of the contract.
9. **NON-PUBLIC WORKS BIDS:** A payment bond will be required for this bid. The amount of the bond will be 100% of the contract price unless otherwise indicated in the specifications. The payment bond shall be supplied at the signing of the contract.
10. All bidders must comply with the requirements stated in the attached "Standard Insurance Requirements" sheet attached to this bid solicitation. Failure to comply with this instruction will result in bid rejection.
11. A bid bond will be required with bid submission in the amount of 5% of the total bid, unless otherwise stated in the bid specifications. All sureties must be in original format (no copies) When submitting a bid online, vendors must submit an electronic bid bond through the respective online clearinghouse bond management system(s) as indicated in the electronic bid solicitation on Central Auction House. No scanned paper copies of any bid bond will be accepted as part of the electronic bid submission.
12. This is a requirements contract to be provided on an as needed basis. JEFFERSON PARISH makes no representations on warranties with regard to minimum guaranteed quantities unless otherwise stated in the bid specifications.
13. Freight charges should be included in total cost when quoting. If not quoted FOB DELIVERED, freight must be quoted as a separate item. Bid may be rejected if not quoted FOB DELIVERED or if freight charges are not indicated on bid form.
14. **PUBLIC WORKS BIDS - Completed, Signed and Properly Notarized Affidavits Required;** This applies to all solicitations for construction, alteration or demolition of public buildings or projects, in conformity with the provisions contained in LSA-RS 38:2212.9, LSA-RS 38:2212.10, LSA-RS 38:2224, and Sec 2-923.1 of the Jefferson Parish Code of Ordinances. For bidding purposes, all bidders must submit with bid submission COMPLETED, SIGNED and PROPERLY NOTARIZED Affidavits, including: Non-Conviction Affidavit, Non-Collusion Affidavit, Campaign Contribution Affidavit, Debt Disclosures Affidavit and E-Verify Affidavit. For the convenience of vendors, all affidavits have been combined into one form entitled PUBLIC WORKS BID AFFIDAVIT. This affidavit must be submitted in its original format, and without material alteration, in order to be compliant and for the bid to be considered responsive. A scanned copy of the completed, signed and properly notarized affidavit may be submitted with the bid, however, the successful bidder must submit the original affidavit in its original format and without material alteration upon contract execution. Failure to comply will result in the bid submission being rejected as non-responsive. The Parish reserves the right to award bid to the next lowest responsive and responsible bidder in this event.

INSTRUCTIONS FOR BIDDERS AND GENERAL CONDITIONS

15. NON PUBLIC WORK BIDS - Completed, Signed and Properly Notarized Affidavits Required in conformity with the provisions contained in LSA – RS 38:2224 and Sec 2-923.1 of the Jefferson Parish Code of Ordinances. For bidding purposes, all bidders must submit with bid submission COMPLETED, SIGNED and PROPERLY NOTARIZED Affidavits, including: Non-Collusion Affidavit, Debt Disclosures Affidavit and Campaign Contribution Affidavit. For the convenience of vendors, all affidavits have been combined into one form entitled NON PUBLIC WORKS BID AFFIDAVIT. This affidavit must be submitted in its original format, and without material alteration, in order to be compliant and for the bid to be considered responsive. A scanned copy of the completed, signed and properly notarized affidavit may be submitted with the bid, however, the successful bidder must submit the original affidavit in its original format and without material alteration upon contract execution. Failure to comply will result in the bid submission being rejected as non-responsive. The Parish reserves the right to award bid to the next lowest responsive and responsible bidder in this event.

16. The ensuing contract for this bid solicitation may be eligible for FEMA reimbursement and/or Federal funding/reimbursement. As such, the referenced appendix will be applicable accordingly and shall be considered a part of the bid documents. All applicable certifications must be duly completed, signed and submitted with bid submission. Failure to submit applicable certifications with bid submission will result in bid rejection.

17. For this project, the Contractor shall not pay any state or local sales or use taxes on materials and equipment which are affixed and made part of the immovable property of the project or which is permanently incorporated in the project (hereinafter referred to as "applicable materials and equipment."). All purchases of applicable materials or equipment shall be made by the contractor on behalf of and as the agent of Jefferson Parish (Owner), a political subdivision of the State of Louisiana. No state and local sales and use taxes are owed on applicable materials and equipment under the provisions of Act 1029 of the 1991 Regular Session - Louisiana Revised Statute 47:301(8)(c). Owner will furnish to contractor a certificate form which certifies that Owner is not required to pay such state or local sales and use taxes, and contractor shall furnish a copy of such certificate to all vendors or suppliers of the applicable materials and equipment, and report to Owner the amount of taxes not incurred.

It shall be the duty of every parish officer, employee, department, agency, special district, board, and commission: and the duty of every contractor, subcontractor, and licensee of the parish, and the duty of every applicant for certification of eligibility for a parish contract or program, to cooperate with the Inspector General in any investigation, audit, inspection, performance review, or hearing pursuant to JPCO 2-155.10(19). By signing this document, every corporation, partnership, or person contracting with PARISH, whether by cooperative endeavor, intergovernmental agreement, bid, proposal, application or solicitation for a parish contract, and every application for certification of eligibility for a parish contract or program, attests that it understands and will abide by all provisions of JPCO 2-155.10.

TO: JEFFERSON PARISH
PURCHASING DEPT
200 DERBIGNY ST. SUITE 4400
GRETN, LA 70053
(Owner to provide name and address of owner)

BID FOR: TWO (2) YEAR CONTRACT TO PERFOR
RAIL MAINTENANCE (REMOVAL, INST
AND REPAIR) FOR THE JEFFERSON P
DEPARTMENT OF PUBLIC WORKS-STRE
(Owner to provide name of project and
other identifying information)

The undersigned bidder hereby declares and represents that she/he; a) has carefully examined and understands the Bidding Documents, b) has not received, relied on, or based his bid on any verbal instructions contrary to the Bidding Documents or any addenda, c) has personally inspected and is familiar with the project site, and hereby proposes to provide all labor, materials, tools, appliances and facilities as required to perform, in a workmanlike manner, all work and services for the construction and completion of the referenced project, all in strict accordance with the Bidding Documents prepared by: _____

and dated: _____
(Owner to provide name of entity preparing bidding documents.)

Bidders must acknowledge all addenda. The Bidder acknowledges receipt of the following **ADDENDA**: (Enter the number the Designer has assigned to each of the addenda that the Bidder is acknowledging) _____

TOTAL BASE BID: For all work required by the Bidding Documents (including any and all unit prices designated "Base Bid" * but not alternates) the sum of:

_____ Dollars (\$) _____

ALTERNATES: For any and all work required by the Bidding Documents for Alternates including any and all unit prices designated as alternates in the unit price description.

Alternate No. 1 (Owner to provide description of alternate and state whether add or deduct) for the lump sum of:
_____ Dollars (\$) _____

Alternate No. 2 (Owner to provide description of alternate and state whether add or deduct) for the lump sum of:
_____ Dollars (\$) _____

Alternate No. 3 (Owner to provide description of alternate and state whether add or deduct) for the lump sum of:
_____ Dollars (\$) _____

NAME OF BIDDER: _____

ADDRESS OF BIDDER: _____

LOUISIANA CONTRACTOR'S LICENSE NUMBER: _____

NAME OF AUTHORIZED SIGNATORY OF BIDDER: _____

TITLE OF AUTHORIZED SIGNATORY OF BIDDER: _____

SIGNATURE OF AUTHORIZED SIGNATORY OF BIDDER **: _____

DATE: _____

THE FOLLOWING ITEMS ARE TO BE INCLUDED WITH THE SUBMISSION OF THIS LOUISIANA UNIFORM PUBLIC WORK BID FORM:

* The Unit Price Form shall be used if the contract includes unit prices. Otherwise it is not required and need not be included with the form. The number of unit prices that may be included is not limited and additional sheets may be included if needed.

** **A CORPORATE RESOLUTION OR WRITTEN EVIDENCE** of the authority of the person signing the bid for the public work as prescribed by LA-R.S. 38:2218 (B)(5).

BID SECURITY in the form of a bid bond, certified check or cashier's check as prescribed by LA-R.S. 38:2218.(A) is attached to and made a part of this bid.

LOUISIANA UNIFORM PUBLIC WORK BID FORM
UNIT PRICE FORM

Bid# 50-00142748

TO: JEFFERSON PARISH
PURCHASING DEPT
200 DERBIGNY ST. SUITE 4400
GRETNA, LA 70053
(Owner to provide name and
address of owner)

**TWO (2) YEAR CONTRACT TO PERFORM GUARD-
RAIL MAINTENANCE (REMOVAL, INSTALLATION
AND REPAIR) FOR THE JEFFERSON PARISH
DEPARTMENT OF PUBLIC WORKS-STREETS AND**
(Owner to provide name of project
and other identifying information)

**UNIT PRICES: This form shall be used for any and all work required by the Bidding Documents and described as unit prices.
Amounts shall be stated in figures and only in figures.**

DESCRIPTION:	<input checked="" type="checkbox"/> Base Bid <input type="checkbox"/> Alt.#__	0010 FURNISH AND REPLACE 25 FEET-0 INCH SRT 350 GUARDRAIL TWO (2) YEAR CONTRACT FOR GUARDRAIL MAINTENANCE (REMOVAL, INSTALLATION AND		
REF NO.	QUANTITY	UNIT OF MEASURE	UNIT PRICE	UNIT PRICE EXTENSION (Quantity times Unit Price)
0010	5.00	EA		

DESCRIPTION:	<input checked="" type="checkbox"/> Base Bid <input type="checkbox"/> Alt.#__	0020 FURNISH AND REPLACE 12 FEET-6 INCH SRT 350 ANCHOR RAIL		
REF NO.	QUANTITY	UNIT OF MEASURE	UNIT PRICE	UNIT PRICE EXTENSION (Quantity times Unit Price)
0020	15.00	EA		

DESCRIPTION:	<input checked="" type="checkbox"/> Base Bid <input type="checkbox"/> Alt.#__	0030 FURNISH AND REPLACE SRT 350 SLOT GUARDS		
REF NO.	QUANTITY	UNIT OF MEASURE	UNIT PRICE	UNIT PRICE EXTENSION (Quantity times Unit Price)
0030	5.00	EA		

DESCRIPTION:	<input checked="" type="checkbox"/> Base Bid <input type="checkbox"/> Alt.#__	0040 FURNISH AND REPLACE SRT 350 6 FEET- 6 INCH CABLE ASSEMBLY		
REF NO.	QUANTITY	UNIT OF MEASURE	UNIT PRICE	UNIT PRICE EXTENSION (Quantity times Unit Price)
0040	5.00	EA		

DESCRIPTION:	<input checked="" type="checkbox"/> Base Bid <input type="checkbox"/> Alt.#__	0050 FURNISH AND INSTALL COMPLETE 37 FEET-6 INCH SRT 350 END TREATMENT		
REF NO.	QUANTITY	UNIT OF MEASURE	UNIT PRICE	UNIT PRICE EXTENSION (Quantity times Unit Price)
0050	5.00	EA		

DESCRIPTION:	<input checked="" type="checkbox"/> Base Bid <input type="checkbox"/> Alt.#__	0060 FURNISH AND INSTALL W6 X 20 PEDESTAL GUARDRAIL POSTS (UP TO 36 INCH IN OVERALL HEIGHT) USING PRE-EXISTING HOLES IN BRIDGE DECK		
REF NO.	QUANTITY	UNIT OF MEASURE	UNIT PRICE	UNIT PRICE EXTENSION (Quantity times Unit Price)
0060	5.00	EA		

DESCRIPTION:	<input checked="" type="checkbox"/> Base Bid <input type="checkbox"/> Alt.#__	0070 FURNISH AND INSTALL W6 X 20 PEDESTAL GUARDRAIL POSTS (UP TO 36 INCH IN OVERALL HEIGHT) DRILL NEW HOLES IN BRIDGE DECK		
REF NO.	QUANTITY	UNIT OF MEASURE	UNIT PRICE	UNIT PRICE EXTENSION (Quantity times Unit Price)
0070	5.00	EA		

DESCRIPTION:	<input checked="" type="checkbox"/> Base Bid <input type="checkbox"/> Alt.#__	0080 FURNISH AND INSTALL W6 X 20 PEDESTAL GUARDRAIL POSTS (37 INCH TO 60 INCH OVERALL HEIGHT) USING PRE-EXISTING HOLES IN BRIDGE DECK		
REF NO.	QUANTITY	UNIT OF MEASURE	UNIT PRICE	UNIT PRICE EXTENSION (Quantity times Unit Price)
0080	3.00	EA		

Wording for "DESCRIPTION" is to be provided by the Owner.
All quantities are estimated. The contractor will be paid based upon actual quantities as verified by the Owner.

LOUISIANA UNIFORM PUBLIC WORK BID FORM
UNIT PRICE FORM

Bid# 50-00142748

TO: JEFFERSON PARISH
PURCHASING DEPT
200 DERBIGNY ST. SUITE 4400
GRETN, LA 70053
(Owner to provide name and
address of owner)

**TWO (2) YEAR CONTRACT TO PERFORM GUARD-
RAIL MAINTENANCE (REMOVAL, INSTALLATION
AND REPAIR) FOR THE JEFFERSON PARISH
DEPARTMENT OF PUBLIC WORKS-STREETS AND**
(Owner to provide name of project
and other identifying information)

**UNIT PRICES: This form shall be used for any and all work required by the Bidding Documents and described as unit prices.
Amounts shall be stated in figures and only in figures.**

DESCRIPTION:	<input checked="" type="checkbox"/> Base Bid <input type="checkbox"/> Alt.#__	0090 FURNISH AND INSTALL W6 X 20 PEDESTAL GUARDRAIL POSTS (37 INCH TO 60 INCH IN OVERALL HEIGHT) DRILL NEW HOLES IN BRIDGE DECK	
REF NO.	QUANTITY	UNIT OF MEASURE	UNIT PRICE EXTENSION (Quantity times Unit Price)
0090	3.00	EA	

DESCRIPTION:	<input checked="" type="checkbox"/> Base Bid <input type="checkbox"/> Alt.#__	0100 FURNISH AND INSTALL STEEL POSTS ATTACHED TO BRIDGE FASCIA (6 FEET W6X15)	
REF NO.	QUANTITY	UNIT OF MEASURE	UNIT PRICE EXTENSION (Quantity times Unit Price)
0100	5.00	EA	

DESCRIPTION:	<input checked="" type="checkbox"/> Base Bid <input type="checkbox"/> Alt.#__	0110 FURNISH AND INSTALL TREATED TIMBER CRT POST 6 INCH X 8 INCH X 6 FEET-0 INCH	
REF NO.	QUANTITY	UNIT OF MEASURE	UNIT PRICE EXTENSION (Quantity times Unit Price)
0110	30.00	EA	

DESCRIPTION:	<input checked="" type="checkbox"/> Base Bid <input type="checkbox"/> Alt.#__	0120 FURNISH AND INSTALL TREATED TIMBER BCT POST 5 1/2 INCH X 7 1/2 INCH X 45 INCH	
REF NO.	QUANTITY	UNIT OF MEASURE	UNIT PRICE EXTENSION (Quantity times Unit Price)
0120	40.00	EA	

DESCRIPTION:	<input checked="" type="checkbox"/> Base Bid <input type="checkbox"/> Alt.#__	0130 FURNISH AND INSTALL STANDARD STEEL LINE POST (6 FEET W6X9)	
REF NO.	QUANTITY	UNIT OF MEASURE	UNIT PRICE EXTENSION (Quantity times Unit Price)
0130	50.00	EA	

DESCRIPTION:	<input checked="" type="checkbox"/> Base Bid <input type="checkbox"/> Alt.#__	0140 FURNISH AND INSTALL TREATED TIMBER POST 10 INCH X 10 INCH X 8 FEET-0 INCH	
REF NO.	QUANTITY	UNIT OF MEASURE	UNIT PRICE EXTENSION (Quantity times Unit Price)
0140	10.00	EA	

DESCRIPTION:	<input checked="" type="checkbox"/> Base Bid <input type="checkbox"/> Alt.#__	0150 FURNISH AND INSTALL TREATED TIMBER POST 10 INCH X 10 INCH X 6 FEET-0 INCH	
REF NO.	QUANTITY	UNIT OF MEASURE	UNIT PRICE EXTENSION (Quantity times Unit Price)
0150	3.00	EA	

DESCRIPTION:	<input checked="" type="checkbox"/> Base Bid <input type="checkbox"/> Alt.#__	0160 FURNISH AND INSTALL TREATED TIMBER POST 8 INCH X 8 INCH X 6 FEET-0 INCH	
REF NO.	QUANTITY	UNIT OF MEASURE	UNIT PRICE EXTENSION (Quantity times Unit Price)
0160	17.00	EA	

Wording for "DESCRIPTION" is to be provided by the Owner.
All quantities are estimated. The contractor will be paid based upon actual quantities as verified by the Owner.

LOUISIANA UNIFORM PUBLIC WORK BID FORM
UNIT PRICE FORM

Bid# 50-00142748

TO: JEFFERSON PARISH
PURCHASING DEPT
200 DERBIGNY ST. SUITE 4400
GRETNA, LA 70053
(Owner to provide name and
address of owner)

**TWO (2) YEAR CONTRACT TO PERFORM GUARD-
RAIL MAINTENANCE (REMOVAL, INSTALLATION
AND REPAIR) FOR THE JEFFERSON PARISH
DEPARTMENT OF PUBLIC WORKS-STREETS AND**
(Owner to provide name of project
and other identifying information)

UNIT PRICES: This form shall be used for any and all work required by the Bidding Documents and described as unit prices.
Amounts shall be stated in figures and only in figures.

DESCRIPTION:	<input checked="" type="checkbox"/> Base Bid <input type="checkbox"/> Alt.#__	0170 FURNISH AND INSTALL TREATED TIMBER POST 8 INCH X 8 INCH X 8 FEET-0 INCH		
REF NO.	QUANTITY	UNIT OF MEASURE	UNIT PRICE	UNIT PRICE EXTENSION (Quantity times Unit Price)
0170	5.00	EA		

DESCRIPTION:	<input checked="" type="checkbox"/> Base Bid <input type="checkbox"/> Alt.#__	0180 FURNISH AND INSTALL TREATED TIMBER POST 6 INCH X 8 INCH X 6 FEET-6 INCH		
REF NO.	QUANTITY	UNIT OF MEASURE	UNIT PRICE	UNIT PRICE EXTENSION (Quantity times Unit Price)
0180	15.00	EA		

DESCRIPTION:	<input checked="" type="checkbox"/> Base Bid <input type="checkbox"/> Alt.#__	0185 FURNISH AND INSTALL TREATED TIMBER POST 6 INCH X 8 INCH X 6 FEET-0 INCH		
REF NO.	QUANTITY	UNIT OF MEASURE	UNIT PRICE	UNIT PRICE EXTENSION (Quantity times Unit Price)
0185	125.00	EA		

DESCRIPTION:	<input checked="" type="checkbox"/> Base Bid <input type="checkbox"/> Alt.#__	0190 FURNISH AND REPLACE THRIE BEAM GUARDRAIL (POSTS NOT INCLUDED), 6 FEET-3 INCH		
REF NO.	QUANTITY	UNIT OF MEASURE	UNIT PRICE	UNIT PRICE EXTENSION (Quantity times Unit Price)
0190	5.00	EA		

DESCRIPTION:	<input checked="" type="checkbox"/> Base Bid <input type="checkbox"/> Alt.#__	0200 FURNISH AND REPLACE THRIE BEAM GUARDRAIL (POSTS NOT INCLUDED), 25 FEET-6 INCH		
REF NO.	QUANTITY	UNIT OF MEASURE	UNIT PRICE	UNIT PRICE EXTENSION (Quantity times Unit Price)
0200	10.00	EA		

DESCRIPTION:	<input checked="" type="checkbox"/> Base Bid <input type="checkbox"/> Alt.#__	0210 FURNISH AND REPLACE THRIE BEAM GUARDRAIL (POSTS NOT INCLUDED), 25 FEET-0 INCH		
REF NO.	QUANTITY	UNIT OF MEASURE	UNIT PRICE	UNIT PRICE EXTENSION (Quantity times Unit Price)
0210	10.00	EA		

DESCRIPTION:	<input checked="" type="checkbox"/> Base Bid <input type="checkbox"/> Alt.#__	0220 FURNISH AND REPLACE THRIE BEAM TO W-BEAM TRANSITION (POSTS NOT INCLUDED), 12 FEET-6 INCH		
REF NO.	QUANTITY	UNIT OF MEASURE	UNIT PRICE	UNIT PRICE EXTENSION (Quantity times Unit Price)
0220	10.00	EA		

DESCRIPTION:	<input checked="" type="checkbox"/> Base Bid <input type="checkbox"/> Alt.#__	0230 FURNISH AND REPLACE W-BEAM GUARDRAIL (POSTS NOT INCLUDED), 6 FEET-3 INCH		
REF NO.	QUANTITY	UNIT OF MEASURE	UNIT PRICE	UNIT PRICE EXTENSION (Quantity times Unit Price)
0230	10.00	EA		

Wording for "DESCRIPTION" is to be provided by the Owner.
All quantities are estimated. The contractor will be paid based upon actual quantities as verified by the Owner.

LOUISIANA UNIFORM PUBLIC WORK BID FORM
UNIT PRICE FORM

Bid# 50-00142748

TO: JEFFERSON PARISH
PURCHASING DEPT
200 DERBIGNY ST. SUITE 4400
GRETN, LA 70053
 (Owner to provide name and
 address of owner)

**TWO (2) YEAR CONTRACT TO PERFORM GUARD-
 RAIL MAINTENANCE (REMOVAL, INSTALLATION
 AND REPAIR) FOR THE JEFFERSON PARISH
 DEPARTMENT OF PUBLIC WORKS-STREETS AND**
 (Owner to provide name of project
 and other identifying information)

UNIT PRICES: This form shall be used for any and all work required by the Bidding Documents and described as unit prices.
 Amounts shall be stated in figures and only in figures.

DESCRIPTION:	<input checked="" type="checkbox"/> Base Bid	0240 FURNISH AND REPLACE W-BEAM GUARDRAIL (POSTS NOT INCLUDED), 12 FEET-6 INCH		
	<input type="checkbox"/> Alt.#__			
REF NO.	QUANTITY	UNIT OF MEASURE	UNIT PRICE	UNIT PRICE EXTENSION (Quantity times Unit Price)
0240	20.00	EA		

DESCRIPTION:	<input checked="" type="checkbox"/> Base Bid	0250 FURNISH AND REPLACE W-BEAM GUARDRAIL (POSTS NOT INCLUDED), 25 FEET-0 INCH		
	<input type="checkbox"/> Alt.#__			
REF NO.	QUANTITY	UNIT OF MEASURE	UNIT PRICE	UNIT PRICE EXTENSION (Quantity times Unit Price)
0250	60.00	EA		

DESCRIPTION:	<input checked="" type="checkbox"/> Base Bid	0260 FURNISH AND INSTALL W-BEAM MGS SECOND RAIL 10 FEET-5 INCH		
	<input type="checkbox"/> Alt.#__			
REF NO.	QUANTITY	UNIT OF MEASURE	UNIT PRICE	UNIT PRICE EXTENSION (Quantity times Unit Price)
0260	5.00	EA		

DESCRIPTION:	<input checked="" type="checkbox"/> Base Bid	0270 FURNISH AND INSTALL W-BEAM MGS THIRD RAIL 13 FEET-6 1/2 INCH		
	<input type="checkbox"/> Alt.#__			
REF NO.	QUANTITY	UNIT OF MEASURE	UNIT PRICE	UNIT PRICE EXTENSION (Quantity times Unit Price)
0270	5.00	EA		

DESCRIPTION:	<input checked="" type="checkbox"/> Base Bid	0280 FURNISH AND INSTALL W-BEAM MGS RAIL SECTION 9 FEET-4 1/2 INCH		
	<input type="checkbox"/> Alt.#__			
REF NO.	QUANTITY	UNIT OF MEASURE	UNIT PRICE	UNIT PRICE EXTENSION (Quantity times Unit Price)
0280	5.00	EA		

DESCRIPTION:	<input checked="" type="checkbox"/> Base Bid	0290 FURNISH AND INSTALL W-BEAM MGS RAIL SECTION 12 FEET-6 INCH		
	<input type="checkbox"/> Alt.#__			
REF NO.	QUANTITY	UNIT OF MEASURE	UNIT PRICE	UNIT PRICE EXTENSION (Quantity times Unit Price)
0290	5.00	EA		

DESCRIPTION:	<input checked="" type="checkbox"/> Base Bid	0300 FURNISH AND INSTALL W-BEAM GUARDRAIL END SECTION ANCHOR RAIL 12 FEET-6 INCH		
	<input type="checkbox"/> Alt.#__			
REF NO.	QUANTITY	UNIT OF MEASURE	UNIT PRICE	UNIT PRICE EXTENSION (Quantity times Unit Price)
0300	15.00	EA		

DESCRIPTION:	<input checked="" type="checkbox"/> Base Bid	0310 FURNISH AND INSTALL COMPLETE THRIE BEAM GUARDRAIL ANCHOR SECTION (TRAINING END)		
	<input type="checkbox"/> Alt.#__			
REF NO.	QUANTITY	UNIT OF MEASURE	UNIT PRICE	UNIT PRICE EXTENSION (Quantity times Unit Price)
0310	5.00	EA		

Wording for "DESCRIPTION" is to be provided by the Owner.
 All quantities are estimated. The contractor will be paid based upon actual quantities as verified by the Owner.

LOUISIANA UNIFORM PUBLIC WORK BID FORM
UNIT PRICE FORM

Bid# 50-00142748

TO: JEFFERSON PARISH
PURCHASING DEPT
200 DERBIGNY ST. SUITE 4400
GRETN, LA 70053
(Owner to provide name and
address of owner)

**TWO (2) YEAR CONTRACT TO PERFORM GUARD-
RAIL MAINTENANCE (REMOVAL, INSTALLATION
AND REPAIR) FOR THE JEFFERSON PARISH
DEPARTMENT OF PUBLIC WORKS-STREETS AND**
(Owner to provide name of project
and other identifying information)

UNIT PRICES: This form shall be used for any and all work required by the Bidding Documents and described as unit prices.
Amounts shall be stated in figures and only in figures.

DESCRIPTION:	<input checked="" type="checkbox"/> Base Bid <input type="checkbox"/> Alt.#__	0320 FURNISH AND INSTALL COMPLETE W-BEAM GUARDRAIL ANCHOR SECTION (TRAINING END)		
REF NO.	QUANTITY	UNIT OF MEASURE	UNIT PRICE	UNIT PRICE EXTENSION (Quantity times Unit Price)
0320	5.00	EA		

DESCRIPTION:	<input checked="" type="checkbox"/> Base Bid <input type="checkbox"/> Alt.#__	0330 FURNISH AND INSTALL COMPLETE W-BEAM ANCHOR SECTION 31 INCH (TRAINING END)		
REF NO.	QUANTITY	UNIT OF MEASURE	UNIT PRICE	UNIT PRICE EXTENSION (Quantity times Unit Price)
0330	5.00	EA		

DESCRIPTION:	<input checked="" type="checkbox"/> Base Bid <input type="checkbox"/> Alt.#__	0340 FURNISH AND INSTALL COMPLETE THRIE BEAM ANCHOR SECION 31 INCH (TRAINING END)		
REF NO.	QUANTITY	UNIT OF MEASURE	UNIT PRICE	UNIT PRICE EXTENSION (Quantity times Unit Price)
0340	5.00	EA		

DESCRIPTION:	<input checked="" type="checkbox"/> Base Bid <input type="checkbox"/> Alt.#__	0350 FURNISH AND INSTALL FOUNDATION TUBE		
REF NO.	QUANTITY	UNIT OF MEASURE	UNIT PRICE	UNIT PRICE EXTENSION (Quantity times Unit Price)
0350	5.00	EA		

DESCRIPTION:	<input checked="" type="checkbox"/> Base Bid <input type="checkbox"/> Alt.#__	0360 FURNISH AND INSTALL PIPE SLEEVE		
REF NO.	QUANTITY	UNIT OF MEASURE	UNIT PRICE	UNIT PRICE EXTENSION (Quantity times Unit Price)
0360	5.00	EA		

DESCRIPTION:	<input checked="" type="checkbox"/> Base Bid <input type="checkbox"/> Alt.#__	0370 FURNISH AND INSTALL BEARING PLATE		
REF NO.	QUANTITY	UNIT OF MEASURE	UNIT PRICE	UNIT PRICE EXTENSION (Quantity times Unit Price)
0370	10.00	EA		

DESCRIPTION:	<input checked="" type="checkbox"/> Base Bid <input type="checkbox"/> Alt.#__	0380 FURNISH AND INSTALL CABLE ANCHOR BOX		
REF NO.	QUANTITY	UNIT OF MEASURE	UNIT PRICE	UNIT PRICE EXTENSION (Quantity times Unit Price)
0380	15.00	EA		

DESCRIPTION:	<input checked="" type="checkbox"/> Base Bid <input type="checkbox"/> Alt.#__	0390 FURNISH AND INSTALL BCT CABLE ANCHOR ASSEMBLY		
REF NO.	QUANTITY	UNIT OF MEASURE	UNIT PRICE	UNIT PRICE EXTENSION (Quantity times Unit Price)
0390	15.00	EA		

Wording for "DESCRIPTION" is to be provided by the Owner.
All quantities are estimated. The contractor will be paid based upon actual quantities as verified by the Owner.

LOUISIANA UNIFORM PUBLIC WORK BID FORM
UNIT PRICE FORM

Bid# 50-00142748

TO: JEFFERSON PARISH
PURCHASING DEPT
200 DERBIGNY ST. SUITE 4400
GRETNA, LA 70053
(Owner to provide name and
address of owner)

**TWO (2) YEAR CONTRACT TO PERFORM GUARD-
RAIL MAINTENANCE (REMOVAL, INSTALLATION
AND REPAIR) FOR THE JEFFERSON PARISH
DEPARTMENT OF PUBLIC WORKS-STREETS AND**
(Owner to provide name of project
and other identifying information)

**UNIT PRICES: This form shall be used for any and all work required by the Bidding Documents and described as unit prices.
Amounts shall be stated in figures and only in figures.**

DESCRIPTION:	<input checked="" type="checkbox"/> Base Bid 0400 FURNISH AND INSTALL GROUND STRUT <input type="checkbox"/> Alt.#__			
REF NO.	QUANTITY	UNIT OF MEASURE	UNIT PRICE	UNIT PRICE EXTENSION (Quantity times Unit Price)
0400	5.00	EA		

DESCRIPTION:	<input checked="" type="checkbox"/> Base Bid 0410 FURNISH AND INSTALL IMPACT HEAD (FLEAT 350) <input type="checkbox"/> Alt.#__			
REF NO.	QUANTITY	UNIT OF MEASURE	UNIT PRICE	UNIT PRICE EXTENSION (Quantity times Unit Price)
0410	5.00	EA		

DESCRIPTION:	<input checked="" type="checkbox"/> Base Bid 0420 FURNISH AND INSTALL IMPACT HEAD (MFLEAT) <input type="checkbox"/> Alt.#__			
REF NO.	QUANTITY	UNIT OF MEASURE	UNIT PRICE	UNIT PRICE EXTENSION (Quantity times Unit Price)
0420	5.00	EA		

DESCRIPTION:	<input checked="" type="checkbox"/> Base Bid 0430 FURNISH AND INSTALL IMPACT HEAD (SKT 350) <input type="checkbox"/> Alt.#__			
REF NO.	QUANTITY	UNIT OF MEASURE	UNIT PRICE	UNIT PRICE EXTENSION (Quantity times Unit Price)
0430	10.00	EA		

DESCRIPTION:	<input checked="" type="checkbox"/> Base Bid 0440 FURNISH AND INSTALL IMPACT HEAD (MSKT) <input type="checkbox"/> Alt.#__			
REF NO.	QUANTITY	UNIT OF MEASURE	UNIT PRICE	UNIT PRICE EXTENSION (Quantity times Unit Price)
0440	5.00	EA		

DESCRIPTION:	<input checked="" type="checkbox"/> Base Bid 0450 FURNISH AND INSTALL HINGED SECOND POST BOTTOM <input type="checkbox"/> Alt.#__			
REF NO.	QUANTITY	UNIT OF MEASURE	UNIT PRICE	UNIT PRICE EXTENSION (Quantity times Unit Price)
0450	3.00	EA		

DESCRIPTION:	<input checked="" type="checkbox"/> Base Bid 0460 FURNISH AND INSTALL HINGED FIRST POST BOTTOM <input type="checkbox"/> Alt.#__			
REF NO.	QUANTITY	UNIT OF MEASURE	UNIT PRICE	UNIT PRICE EXTENSION (Quantity times Unit Price)
0460	3.00	EA		

DESCRIPTION:	<input checked="" type="checkbox"/> Base Bid 0470 FURNISH AND INSTALL HINGED SECOND POST UPPER <input type="checkbox"/> Alt.#__			
REF NO.	QUANTITY	UNIT OF MEASURE	UNIT PRICE	UNIT PRICE EXTENSION (Quantity times Unit Price)
0470	5.00	EA		

Wording for "DESCRIPTION" is to be provided by the Owner.
All quantities are estimated. The contractor will be paid based upon actual quantities as verified by the Owner.

LOUISIANA UNIFORM PUBLIC WORK BID FORM
UNIT PRICE FORM

Bid# 50-00142748

TO: JEFFERSON PARISH
PURCHASING DEPT
200 DERBIGNY ST. SUITE 4400
GRETNA, LA 70053
(Owner to provide name and
address of owner)

**TWO (2) YEAR CONTRACT TO PERFORM GUARD-
RAIL MAINTENANCE (REMOVAL, INSTALLATION
AND REPAIR) FOR THE JEFFERSON PARISH
DEPARTMENT OF PUBLIC WORKS-STREETS AND**
(Owner to provide name of project
and other identifying information)

**UNIT PRICES: This form shall be used for any and all work required by the Bidding Documents and described as unit prices.
Amounts shall be stated in figures and only in figures.**

DESCRIPTION:	<input checked="" type="checkbox"/> Base Bid 0480 FURNISH AND INSTALL FIRST POST TOP (6X6X1/8 INCH TUBE) <input type="checkbox"/> Alt.#__			
REF NO.	QUANTITY	UNIT OF MEASURE	UNIT PRICE	UNIT PRICE EXTENSION (Quantity times Unit Price)
0480	5.00	EA		

DESCRIPTION:	<input checked="" type="checkbox"/> Base Bid 0490 FURNISH AND INSTALL FIRST POST BOTTOM (6 FEET W6X15) <input type="checkbox"/> Alt.#__			
REF NO.	QUANTITY	UNIT OF MEASURE	UNIT PRICE	UNIT PRICE EXTENSION (Quantity times Unit Price)
0490	3.00	EA		

DESCRIPTION:	<input checked="" type="checkbox"/> Base Bid 0500 UNIVERSAL HINGED SECOND POST UPPER (SKT 350, FLEAT 350, MSKT) <input type="checkbox"/> Alt.#__			
REF NO.	QUANTITY	UNIT OF MEASURE	UNIT PRICE	UNIT PRICE EXTENSION (Quantity times Unit Price)
0500	5.00	EA		

DESCRIPTION:	<input checked="" type="checkbox"/> Base Bid 0510 FURNISH AND INSTALL MASH BEARING PLATE (MFLEAT) <input type="checkbox"/> Alt.#__			
REF NO.	QUANTITY	UNIT OF MEASURE	UNIT PRICE	UNIT PRICE EXTENSION (Quantity times Unit Price)
0510	5.00	EA		

DESCRIPTION:	<input checked="" type="checkbox"/> Base Bid 0520 FURNISH AND INSTALL TREATED TIMBER BLOCK 6 INCH X 8 INCH X 1 FOOT-2 INCH <input type="checkbox"/> Alt.#__			
REF NO.	QUANTITY	UNIT OF MEASURE	UNIT PRICE	UNIT PRICE EXTENSION (Quantity times Unit Price)
0520	220.00	EA		

DESCRIPTION:	<input checked="" type="checkbox"/> Base Bid 0530 FURNISH AND INSTALL TREATED TIMBER BLOCK 8 INCH X 8 INCH X 1 FOOT-10 INCH <input type="checkbox"/> Alt.#__			
REF NO.	QUANTITY	UNIT OF MEASURE	UNIT PRICE	UNIT PRICE EXTENSION (Quantity times Unit Price)
0530	25.00	EA		

DESCRIPTION:	<input checked="" type="checkbox"/> Base Bid 0540 FURNISH AND INSTALL TREATED TIMBER BLOCK 8 INCH X 8 INCH X 1 FOOT-2 INCH <input type="checkbox"/> Alt.#__			
REF NO.	QUANTITY	UNIT OF MEASURE	UNIT PRICE	UNIT PRICE EXTENSION (Quantity times Unit Price)
0540	20.00	EA		

DESCRIPTION:	<input checked="" type="checkbox"/> Base Bid 0550 FURNISH AND INSTALL TREATED TIMBER BLOCK 6 INCH X 8 INCH X 1 FOOT-10 1/2 <input type="checkbox"/> Alt.#__ INCH			
REF NO.	QUANTITY	UNIT OF MEASURE	UNIT PRICE	UNIT PRICE EXTENSION (Quantity times Unit Price)
0550	40.00	EA		

Wording for "DESCRIPTION" is to be provided by the Owner.
All quantities are estimated. The contractor will be paid based upon actual quantities as verified by the Owner.

LOUISIANA UNIFORM PUBLIC WORK BID FORM
UNIT PRICE FORM

Bid# 50-00142748

TO: JEFFERSON PARISH
PURCHASING DEPT
200 DERBIGNY ST. SUITE 4400
GRETN, LA 70053
(Owner to provide name and
address of owner)

**TWO (2) YEAR CONTRACT TO PERFORM GUARD-
RAIL MAINTENANCE (REMOVAL, INSTALLATION
AND REPAIR) FOR THE JEFFERSON PARISH
DEPARTMENT OF PUBLIC WORKS-STREETS AND**
(Owner to provide name of project
and other identifying information)

UNIT PRICES: This form shall be used for any and all work required by the Bidding Documents and described as unit prices. Amounts shall be stated in figures and only in figures.

DESCRIPTION:	<input checked="" type="checkbox"/> Base Bid	0560 FURNISH AND INSTALL COMPLETE FLARED 37 FEET-6 INCH END TREATMENT, NCHRP 350		
	<input type="checkbox"/> Alt.#__	TL-3, NON ENERGY-ABSORBING		
REF NO.	QUANTITY	UNIT OF MEASURE	UNIT PRICE	UNIT PRICE EXTENSION (Quantity times Unit Price)
0560	5.00	EA		

DESCRIPTION:	<input checked="" type="checkbox"/> Base Bid	0570 FURNISH AND INSTALL COMPLETE TANGENT 25 FEET-0 INCH END TREATMENT,		
	<input type="checkbox"/> Alt.#__	NCHRP 350 TL-2, ENERGY-ABSORBING		
REF NO.	QUANTITY	UNIT OF MEASURE	UNIT PRICE	UNIT PRICE EXTENSION (Quantity times Unit Price)
0570	5.00	EA		

DESCRIPTION:	<input checked="" type="checkbox"/> Base Bid	0580 FURNISH AND INSTALL COMPLETE TANGENT 50 FEET-0 INCH END TREATMENT,		
	<input type="checkbox"/> Alt.#__	NCHRP 350 TL-3, ENERGY-ABSORBING		
REF NO.	QUANTITY	UNIT OF MEASURE	UNIT PRICE	UNIT PRICE EXTENSION (Quantity times Unit Price)
0580	5.00	EA		

DESCRIPTION:	<input checked="" type="checkbox"/> Base Bid	0590 FURNISH AND INSTALL COMPLETE FLARED 25 INCH-0 INCH END TREATMENT, NCHRP 350		
	<input type="checkbox"/> Alt.#__	TL-2, ENERGY-ABSORBING		
REF NO.	QUANTITY	UNIT OF MEASURE	UNIT PRICE	UNIT PRICE EXTENSION (Quantity times Unit Price)
0590	5.00	EA		

DESCRIPTION:	<input checked="" type="checkbox"/> Base Bid	0600 FURNISH AND INSTALL COMPLETE FLARED 50 INCH-0 INCH END TREATMENT, NCHRP 350		
	<input type="checkbox"/> Alt.#__	TL-3, ENERGY-ABSORBING		
REF NO.	QUANTITY	UNIT OF MEASURE	UNIT PRICE	UNIT PRICE EXTENSION (Quantity times Unit Price)
0600	3.00	EA		

DESCRIPTION:	<input checked="" type="checkbox"/> Base Bid	0610 FURNISH AND INSTALL COMPLETE TANGENT 25 FEET-0 INCH END TREATMENT,		
	<input type="checkbox"/> Alt.#__	MASH TL-2, ENERGY-ABSORBING		
REF NO.	QUANTITY	UNIT OF MEASURE	UNIT PRICE	UNIT PRICE EXTENSION (Quantity times Unit Price)
0610	3.00	EA		

DESCRIPTION:	<input checked="" type="checkbox"/> Base Bid	0620 FURNISH AND INSTALL COMPLETE TANGENT 50 FEET-0 INCH END TREATMENT,		
	<input type="checkbox"/> Alt.#__	MASH TL-3, ENERGY-ABSORBING		
REF NO.	QUANTITY	UNIT OF MEASURE	UNIT PRICE	UNIT PRICE EXTENSION (Quantity times Unit Price)
0620	10.00	EA		

DESCRIPTION:	<input checked="" type="checkbox"/> Base Bid	0630 FURNISH AND INSTALL COMPLETE FLARED 39 FEET-7INCH END TREATMENT, MASH TL-3,		
	<input type="checkbox"/> Alt.#__	ENERGY-ABSORBING		
REF NO.	QUANTITY	UNIT OF MEASURE	UNIT PRICE	UNIT PRICE EXTENSION (Quantity times Unit Price)
0630	3.00	EA		

Wording for "DESCRIPTION" is to be provided by the Owner.
All quantities are estimated. The contractor will be paid based upon actual quantities as verified by the Owner.

LOUISIANA UNIFORM PUBLIC WORK BID FORM
UNIT PRICE FORM

Bid# 50-00142748

TO: JEFFERSON PARISH
PURCHASING DEPT
200 DERBIGNY ST. SUITE 4400
GRETN, LA 70053
(Owner to provide name and
address of owner)

**TWO (2) YEAR CONTRACT TO PERFORM GUARD-
RAIL MAINTENANCE (REMOVAL, INSTALLATION
AND REPAIR) FOR THE JEFFERSON PARISH
DEPARTMENT OF PUBLIC WORKS-STREETS AND**
(Owner to provide name of project
and other identifying information)

**UNIT PRICES: This form shall be used for any and all work required by the Bidding Documents and described as unit prices.
Amounts shall be stated in figures and only in figures.**

DESCRIPTION:	<input checked="" type="checkbox"/> Base Bid <input type="checkbox"/> Alt.#__	0640 FURNISH AND INSTALL COMPLETE REDIRECTIVE, NON-GATING MASH TL-2 CRASH CUSHION, SYSTEM LENGTH 13 FEET-0 INCH	
REF NO.	QUANTITY	UNIT OF MEASURE	UNIT PRICE
0640	5.00	EA	UNIT PRICE EXTENSION (Quantity times Unit Price)

DESCRIPTION:	<input checked="" type="checkbox"/> Base Bid <input type="checkbox"/> Alt.#__	0650 FURNISH AND INSTALL COMPLETE REDIRECTIVE, NON-GATING MASH TL-3 CRASH CUSHION, SYSTEM LENGTH 22 FEET-0 INCH	
REF NO.	QUANTITY	UNIT OF MEASURE	UNIT PRICE
0650	3.00	EA	UNIT PRICE EXTENSION (Quantity times Unit Price)

DESCRIPTION:	<input checked="" type="checkbox"/> Base Bid <input type="checkbox"/> Alt.#__	0660 FURNISH AND INSTALL BACKUP ASSEMBLY TENSION STRUT, 24 INCH WIDE	
REF NO.	QUANTITY	UNIT OF MEASURE	UNIT PRICE
0660	3.00	EA	UNIT PRICE EXTENSION (Quantity times Unit Price)

DESCRIPTION:	<input checked="" type="checkbox"/> Base Bid <input type="checkbox"/> Alt.#__	0670 FURNISH AND INSTALL CARTRIDGE ASSEMBLY, TYPE I	
REF NO.	QUANTITY	UNIT OF MEASURE	UNIT PRICE
0670	5.00	EA	UNIT PRICE EXTENSION (Quantity times Unit Price)

DESCRIPTION:	<input checked="" type="checkbox"/> Base Bid <input type="checkbox"/> Alt.#__	0680 FURNISH AND INSTALL CARTRIDGE ASSEMBLY, TYPE II	
REF NO.	QUANTITY	UNIT OF MEASURE	UNIT PRICE
0680	5.00	EA	UNIT PRICE EXTENSION (Quantity times Unit Price)

DESCRIPTION:	<input checked="" type="checkbox"/> Base Bid <input type="checkbox"/> Alt.#__	0690 FURNISH AND INSTALL STEEL NOSE ASSEMBLY, NARROW, YELLOW	
REF NO.	QUANTITY	UNIT OF MEASURE	UNIT PRICE
0690	5.00	EA	UNIT PRICE EXTENSION (Quantity times Unit Price)

DESCRIPTION:	<input checked="" type="checkbox"/> Base Bid <input type="checkbox"/> Alt.#__	0700 FURNISH AND INSTALL MONORAIL ASSEMBLY, 3-BAY	
REF NO.	QUANTITY	UNIT OF MEASURE	UNIT PRICE
0700	5.00	EA	UNIT PRICE EXTENSION (Quantity times Unit Price)

DESCRIPTION:	<input checked="" type="checkbox"/> Base Bid <input type="checkbox"/> Alt.#__	0710 FURNISH AND INSTALL MONORAIL ASSEMBLY, 6-BAY	
REF NO.	QUANTITY	UNIT OF MEASURE	UNIT PRICE
0710	5.00	EA	UNIT PRICE EXTENSION (Quantity times Unit Price)

Wording for "DESCRIPTION" is to be provided by the Owner.
All quantities are estimated. The contractor will be paid based upon actual quantities as verified by the Owner.

LOUISIANA UNIFORM PUBLIC WORK BID FORM
UNIT PRICE FORM

Bid# 50-00142748

TO: JEFFERSON PARISH
PURCHASING DEPT
200 DERBIGNY ST. SUITE 4400
GRETN, LA 70053
 (Owner to provide name and
 address of owner)

**TWO (2) YEAR CONTRACT TO PERFORM GUARD-
 RAIL MAINTENANCE (REMOVAL, INSTALLATION
 AND REPAIR) FOR THE JEFFERSON PARISH
 DEPARTMENT OF PUBLIC WORKS-STREETS AND**
 (Owner to provide name of project
 and other identifying information)

UNIT PRICES: This form shall be used for any and all work required by the Bidding Documents and described as unit prices.
 Amounts shall be stated in figures and only in figures.

DESCRIPTION:	<input checked="" type="checkbox"/> Base Bid 0720 FURNISH AND INSTALL ENDCAP, MONORAIL			
	<input type="checkbox"/> Alt.#__			
REF NO.	QUANTITY	UNIT OF MEASURE	UNIT PRICE	UNIT PRICE EXTENSION (Quantity times Unit Price)
0720	10.00	EA		

DESCRIPTION:	<input checked="" type="checkbox"/> Base Bid 0730 FURNISH AND INSTALL FENDER PANEL ASSEMBLY			
	<input type="checkbox"/> Alt.#__			
REF NO.	QUANTITY	UNIT OF MEASURE	UNIT PRICE	UNIT PRICE EXTENSION (Quantity times Unit Price)
0730	5.00	EA		

DESCRIPTION:	<input checked="" type="checkbox"/> Base Bid 0740 FURNISH AND INSTALL DIAPHRAGM ASSEMBLY, 24 INCH WIDE			
	<input type="checkbox"/> Alt.#__			
REF NO.	QUANTITY	UNIT OF MEASURE	UNIT PRICE	UNIT PRICE EXTENSION (Quantity times Unit Price)
0740	5.00	EA		

DESCRIPTION:	<input checked="" type="checkbox"/> Base Bid 0750 FURNISH AND INSTALL CARTRIDGE SUPPORT BRACKET - DIAPHRAGM			
	<input type="checkbox"/> Alt.#__			
REF NO.	QUANTITY	UNIT OF MEASURE	UNIT PRICE	UNIT PRICE EXTENSION (Quantity times Unit Price)
0750	5.00	EA		

DESCRIPTION:	<input checked="" type="checkbox"/> Base Bid 0760 FURNISH AND INSTALL CARTRIDGE SUPPORT BRACKET - TENSION STRUT BACKUP			
	<input type="checkbox"/> Alt.#__			
REF NO.	QUANTITY	UNIT OF MEASURE	UNIT PRICE	UNIT PRICE EXTENSION (Quantity times Unit Price)
0760	5.00	EA		

DESCRIPTION:	<input checked="" type="checkbox"/> Base Bid 0770 FURNISH AND INSTALL ANCHOR, MP-3 KIT, 3/4 INCH X 6 1/2 INCH			
	<input type="checkbox"/> Alt.#__			
REF NO.	QUANTITY	UNIT OF MEASURE	UNIT PRICE	UNIT PRICE EXTENSION (Quantity times Unit Price)
0770	5.00	EA		

DESCRIPTION:	<input checked="" type="checkbox"/> Base Bid 0780 FURNISH AND INSTALL TRANSITION PANEL, CRASH CUSHION TO SAFETY SHAPE CONCRETE BARRIER, 4 INCH OFFSET			
	<input type="checkbox"/> Alt.#__			
REF NO.	QUANTITY	UNIT OF MEASURE	UNIT PRICE	UNIT PRICE EXTENSION (Quantity times Unit Price)
0780	5.00	EA		

DESCRIPTION:	<input checked="" type="checkbox"/> Base Bid 0790 FURNISH AND INSTALL TRANSITION PANEL, CRASH CUSHION TO THRIE BEAM			
	<input type="checkbox"/> Alt.#__			
REF NO.	QUANTITY	UNIT OF MEASURE	UNIT PRICE	UNIT PRICE EXTENSION (Quantity times Unit Price)
0790	5.00	EA		

Wording for "DESCRIPTION" is to be provided by the Owner.
 All quantities are estimated. The contractor will be paid based upon actual quantities as verified by the Owner.

LOUISIANA UNIFORM PUBLIC WORK BID FORM
UNIT PRICE FORM

Bid# 50-00142748

TO: JEFFERSON PARISH
PURCHASING DEPT
200 DERBIGNY ST. SUITE 4400
GRETN, LA 70053
(Owner to provide name and
address of owner)

**TWO (2) YEAR CONTRACT TO PERFORM GUARD-
RAIL MAINTENANCE (REMOVAL, INSTALLATION
AND REPAIR) FOR THE JEFFERSON PARISH
DEPARTMENT OF PUBLIC WORKS-STREETS AND**
(Owner to provide name of project
and other identifying information)

UNIT PRICES: This form shall be used for any and all work required by the Bidding Documents and described as unit prices. Amounts shall be stated in figures and only in figures.

DESCRIPTION:	<input checked="" type="checkbox"/> Base Bid <input type="checkbox"/> Alt.#__	0800 FURNISH AND INSTALL W-BEAM BRIDGE END TERMINAL WITH BOLTS AND NUTS		
REF NO.	QUANTITY	UNIT OF MEASURE	UNIT PRICE	UNIT PRICE EXTENSION (Quantity times Unit Price)
0800	10.00	EA		

DESCRIPTION:	<input checked="" type="checkbox"/> Base Bid <input type="checkbox"/> Alt.#__	0810 FURNISH AND INSTALL THRIE BEAM BRIDGE END TERMINAL WITH BOLTS AND NUTS		
REF NO.	QUANTITY	UNIT OF MEASURE	UNIT PRICE	UNIT PRICE EXTENSION (Quantity times Unit Price)
0810	10.00	EA		

DESCRIPTION:	<input checked="" type="checkbox"/> Base Bid <input type="checkbox"/> Alt.#__	0820 FURNISH AND INSTALL W-BEAM FLARED END TERMINAL WITH BOLTS AND NUTS		
REF NO.	QUANTITY	UNIT OF MEASURE	UNIT PRICE	UNIT PRICE EXTENSION (Quantity times Unit Price)
0820	10.00	EA		

DESCRIPTION:	<input checked="" type="checkbox"/> Base Bid <input type="checkbox"/> Alt.#__	0830 FURNISH AND INSTALL THRIE BEAM FLARED END TERMINAL WITH BOLTS AND NUTS		
REF NO.	QUANTITY	UNIT OF MEASURE	UNIT PRICE	UNIT PRICE EXTENSION (Quantity times Unit Price)
0830	5.00	EA		

DESCRIPTION:	<input checked="" type="checkbox"/> Base Bid <input type="checkbox"/> Alt.#__	0840 FURNISH AND INSTALL W-BEAM ROUNDED END SECTION		
REF NO.	QUANTITY	UNIT OF MEASURE	UNIT PRICE	UNIT PRICE EXTENSION (Quantity times Unit Price)
0840	10.00	EA		

DESCRIPTION:	<input checked="" type="checkbox"/> Base Bid <input type="checkbox"/> Alt.#__	0850 FURNISH AND INSTALL COMPLETE DOUBLE THRIE BEAM BRIDGE TRANSITION, 25 FEET		
REF NO.	QUANTITY	UNIT OF MEASURE	UNIT PRICE	UNIT PRICE EXTENSION (Quantity times Unit Price)
0850	5.00	EA		

DESCRIPTION:	<input checked="" type="checkbox"/> Base Bid <input type="checkbox"/> Alt.#__	0860 FURNISH AND INSTALL RADIUS W-BEAM GUARDRAIL (POSTS NOT INCLUDED), 12 FEET-6 INCH		
REF NO.	QUANTITY	UNIT OF MEASURE	UNIT PRICE	UNIT PRICE EXTENSION (Quantity times Unit Price)
0860	20.00	EA		

DESCRIPTION:	<input checked="" type="checkbox"/> Base Bid <input type="checkbox"/> Alt.#__	0870 FURNISH AND INSTALL RADIUS THRIE BEAM GUARDRAIL, (POSTS NOT INCLUDED), 12 FEET-6 INCH		
REF NO.	QUANTITY	UNIT OF MEASURE	UNIT PRICE	UNIT PRICE EXTENSION (Quantity times Unit Price)
0870	5.00	EA		

Wording for "DESCRIPTION" is to be provided by the Owner.
All quantities are estimated. The contractor will be paid based upon actual quantities as verified by the Owner.

LOUISIANA UNIFORM PUBLIC WORK BID FORM
UNIT PRICE FORM

Bid# 50-00142748

TO: JEFFERSON PARISH
PURCHASING DEPT
200 DERBIGNY ST. SUITE 4400
GRETN, LA 70053
 (Owner to provide name and
 address of owner)

**TWO (2) YEAR CONTRACT TO PERFORM GUARD-
 RAIL MAINTENANCE (REMOVAL, INSTALLATION
 AND REPAIR) FOR THE JEFFERSON PARISH
 DEPARTMENT OF PUBLIC WORKS-STREETS AND**
 (Owner to provide name of project
 and other identifying information)

UNIT PRICES: This form shall be used for any and all work required by the Bidding Documents and described as unit prices.
 Amounts shall be stated in figures and only in figures.

DESCRIPTION:	<input checked="" type="checkbox"/> Base Bid <input type="checkbox"/> Alt.#__	0880 REMOVAL OF GUARDRAIL INCLUDING POSTS AND BLOCKS, 12 FEET-6 INCH LINEAR FEET		
REF NO.	QUANTITY	UNIT OF MEASURE	UNIT PRICE	UNIT PRICE EXTENSION (Quantity times Unit Price)
0880	75.00	EA		

DESCRIPTION:	<input checked="" type="checkbox"/> Base Bid <input type="checkbox"/> Alt.#__	0890 FURNISH AND INSTALL 4 INCH THICK CONCRETE STRIP, INCLUDING BACKFILL OF POSTS, 3 FEET-0 INCH WIDE		
REF NO.	QUANTITY	UNIT OF MEASURE	UNIT PRICE	UNIT PRICE EXTENSION (Quantity times Unit Price)
0890	50.00	SQYD		

DESCRIPTION:	<input checked="" type="checkbox"/> Base Bid <input type="checkbox"/> Alt.#__	0900 NCHRP-350 APPROVED HIGH DENSITY POLYETHYLENE TRAFFIX LOOPER DRUMS (18 INCH WIDE X 36 INCH TALL) OR APPROVED EQUAL TO INCLUDE:		
REF NO.	QUANTITY	UNIT OF MEASURE	UNIT PRICE	UNIT PRICE EXTENSION (Quantity times Unit Price)
0900	1.00	EA		

DESCRIPTION:	<input checked="" type="checkbox"/> Base Bid <input type="checkbox"/> Alt.#__	0910 NCHRP-350 APPROVED LOW DENSITY POLYETHYLENE TRAFFIX LOOPER CONES (42 INCH TALL) OR APPROVED EQUAL TO INCLUDE:		
REF NO.	QUANTITY	UNIT OF MEASURE	UNIT PRICE	UNIT PRICE EXTENSION (Quantity times Unit Price)
0910	1.00	EA		

DESCRIPTION:	<input checked="" type="checkbox"/> Base Bid <input type="checkbox"/> Alt.#__	0920 EMPKO-LITE TYPE A, C, OR 3-WAY, 3 VOLT HIGH EFFICIENCY LED BARRICADE LIGHT (MODEL 2006 OR APPROVED EQUAL)		
REF NO.	QUANTITY	UNIT OF MEASURE	UNIT PRICE	UNIT PRICE EXTENSION (Quantity times Unit Price)
0920	1.00	EA		

DESCRIPTION:	<input checked="" type="checkbox"/> Base Bid <input type="checkbox"/> Alt.#__	0930 DAVIDSON TRAFFIC CONTROL HIGH DENSITY POLYETHYLENE PLASTIC 8 FEET TYPE III BARRICADE (MODEL T3B OR APPROVED EQUAL)		
REF NO.	QUANTITY	UNIT OF MEASURE	UNIT PRICE	UNIT PRICE EXTENSION (Quantity times Unit Price)
0930	1.00	EA		

DESCRIPTION:	<input checked="" type="checkbox"/> Base Bid <input type="checkbox"/> Alt.#__	0940 YODOCK MODEL 2001M PORTABLE BARRICADE OR APPROVED EQUAL (FOR CONTRACTOR USAGE)		
REF NO.	QUANTITY	UNIT OF MEASURE	UNIT PRICE	UNIT PRICE EXTENSION (Quantity times Unit Price)
0940	1.00	EA		

DESCRIPTION:	<input checked="" type="checkbox"/> Base Bid <input type="checkbox"/> Alt.#__	0942 YODOCK MODEL 2001 PORTABLE BARRICADE OR APPROVED EQUAL (FOR CONTRACTOR USAGE)		
REF NO.	QUANTITY	UNIT OF MEASURE	UNIT PRICE	UNIT PRICE EXTENSION (Quantity times Unit Price)
0942	1.00	EA		

Wording for "DESCRIPTION" is to be provided by the Owner.
 All quantities are estimated. The contractor will be paid based upon actual quantities as verified by the Owner.

LOUISIANA UNIFORM PUBLIC WORK BID FORM
UNIT PRICE FORM

Bid# 50-00142748

TO: JEFFERSON PARISH
PURCHASING DEPT
200 DERBIGNY ST. SUITE 4400
GRETN, LA 70053
(Owner to provide name and
address of owner)

**TWO (2) YEAR CONTRACT TO PERFORM GUARD-
RAIL MAINTENANCE (REMOVAL, INSTALLATION
AND REPAIR) FOR THE JEFFERSON PARISH
DEPARTMENT OF PUBLIC WORKS-STREETS AND**
(Owner to provide name of project
and other identifying information)

UNIT PRICES: This form shall be used for any and all work required by the Bidding Documents and described as unit prices.
Amounts shall be stated in figures and only in figures.

DESCRIPTION:	<input checked="" type="checkbox"/> Base Bid 0945 YODOCK MODEL 2001M PORTABLE BARRICADE OR APPROVED EQUAL			
	<input type="checkbox"/> Alt.#__ (FOR PARISH TO PURCHASE)			
REF NO.	QUANTITY	UNIT OF MEASURE	UNIT PRICE	UNIT PRICE EXTENSION (Quantity times Unit Price)
0945	10.00	EA		

DESCRIPTION:	<input checked="" type="checkbox"/> Base Bid 0947 YODOCK MODEL 2001 PORTABLE BARRICADE OR APPROVED EQUAL			
	<input type="checkbox"/> Alt.#__ (FOR PARISH TO PURCHASE)			
REF NO.	QUANTITY	UNIT OF MEASURE	UNIT PRICE	UNIT PRICE EXTENSION (Quantity times Unit Price)
0947	10.00	EA		

DESCRIPTION:	<input checked="" type="checkbox"/> Base Bid 0950 REMOVAL AND DISPOSAL OF PAVEMENT, 6 INCH OR LESS IN THICKNESS			
	<input type="checkbox"/> Alt.#__			
REF NO.	QUANTITY	UNIT OF MEASURE	UNIT PRICE	UNIT PRICE EXTENSION (Quantity times Unit Price)
0950	5.00	SQYD		

DESCRIPTION:	<input checked="" type="checkbox"/> Base Bid 0960 REMOVAL AND DISPOSAL OF PAVEMENT, GREATER THAN 6 INCH IN THICKNESS			
	<input type="checkbox"/> Alt.#__			
REF NO.	QUANTITY	UNIT OF MEASURE	UNIT PRICE	UNIT PRICE EXTENSION (Quantity times Unit Price)
0960	5.00	SQYD		

DESCRIPTION:	<input checked="" type="checkbox"/> Base Bid 0970 FURNISH AND INSTALL PCC, 4 INCH IN THICKNESS, HIGH EARLY STRENGTH 4000 PSI-			
	<input type="checkbox"/> Alt.#__ 72 HOURS			
REF NO.	QUANTITY	UNIT OF MEASURE	UNIT PRICE	UNIT PRICE EXTENSION (Quantity times Unit Price)
0970	20.00	EA		

DESCRIPTION:	<input checked="" type="checkbox"/> Base Bid 0980 FURNISH AND INSTALL PCC, 6 INCH IN THICKNESS, HIGH EARLY STRENGTH 4000 PSI-			
	<input type="checkbox"/> Alt.#__ 72 HOURS			
REF NO.	QUANTITY	UNIT OF MEASURE	UNIT PRICE	UNIT PRICE EXTENSION (Quantity times Unit Price)
0980	10.00	EA		

DESCRIPTION:	<input checked="" type="checkbox"/> Base Bid 0990 EARTHWORK EXCAVATION BY TRUCK MEASURE			
	<input type="checkbox"/> Alt.#__			
REF NO.	QUANTITY	UNIT OF MEASURE	UNIT PRICE	UNIT PRICE EXTENSION (Quantity times Unit Price)
0990	10.00	CUYD		

DESCRIPTION:	<input checked="" type="checkbox"/> Base Bid 1000 EARTHWORK EXCAVATION BY THEORETICAL VOLUME			
	<input type="checkbox"/> Alt.#__			
REF NO.	QUANTITY	UNIT OF MEASURE	UNIT PRICE	UNIT PRICE EXTENSION (Quantity times Unit Price)
1000	10.00	CUYD		

Wording for "DESCRIPTION" is to be provided by the Owner.
All quantities are estimated. The contractor will be paid based upon actual quantities as verified by the Owner.

LOUISIANA UNIFORM PUBLIC WORK BID FORM
UNIT PRICE FORM

Bid# 50-00142748

TO: JEFFERSON PARISH
PURCHASING DEPT
200 DERBIGNY ST. SUITE 4400
GRETN, LA 70053
 (Owner to provide name and
 address of owner)

**TWO (2) YEAR CONTRACT TO PERFORM GUARD-
 RAIL MAINTENANCE (REMOVAL, INSTALLATION
 AND REPAIR) FOR THE JEFFERSON PARISH
 DEPARTMENT OF PUBLIC WORKS-STREETS AND**
 (Owner to provide name of project
 and other identifying information)

**UNIT PRICES: This form shall be used for any and all work required by the Bidding Documents and described as unit prices.
 Amounts shall be stated in figures and only in figures.**

DESCRIPTION:	<input checked="" type="checkbox"/> Base Bid 1010 RIVER (BATTURE) SAND <input type="checkbox"/> Alt.#__			
REF NO.	QUANTITY	UNIT OF MEASURE	UNIT PRICE	UNIT PRICE EXTENSION (Quantity times Unit Price)
1010	10.00	CUYD		

DESCRIPTION:	<input checked="" type="checkbox"/> Base Bid 1020 PUMP (SUGAR) SAND <input type="checkbox"/> Alt.#__			
REF NO.	QUANTITY	UNIT OF MEASURE	UNIT PRICE	UNIT PRICE EXTENSION (Quantity times Unit Price)
1020	10.00	CUYD		

DESCRIPTION:	<input checked="" type="checkbox"/> Base Bid 1030 CRUSHED LIMESTONE <input type="checkbox"/> Alt.#__			
REF NO.	QUANTITY	UNIT OF MEASURE	UNIT PRICE	UNIT PRICE EXTENSION (Quantity times Unit Price)
1030	5.00	TN		

DESCRIPTION:	<input checked="" type="checkbox"/> Base Bid 1040 BITUMINOUS HOT-MIX ASPHALT WEARING COURSE <input type="checkbox"/> Alt.#__			
REF NO.	QUANTITY	UNIT OF MEASURE	UNIT PRICE	UNIT PRICE EXTENSION (Quantity times Unit Price)
1040	5.00	TN		

DESCRIPTION:	<input checked="" type="checkbox"/> Base Bid 1050 MOBILIZATION - (INSTALLATION AT A NEW GUARDRAIL LOCATION) (PER PROJECT) <input type="checkbox"/> Alt.#__			
REF NO.	QUANTITY	UNIT OF MEASURE	UNIT PRICE	UNIT PRICE EXTENSION (Quantity times Unit Price)
1050	5.00	EA		

DESCRIPTION:	<input checked="" type="checkbox"/> Base Bid 1055 MOBILIZATION - (REPAIR OF DAMAGE AT EXISTING GUARDRAIL LOCATION) <input type="checkbox"/> Alt.#__ (PER PROJECT)			
REF NO.	QUANTITY	UNIT OF MEASURE	UNIT PRICE	UNIT PRICE EXTENSION (Quantity times Unit Price)
1055	60.00	EA		

DESCRIPTION:	<input checked="" type="checkbox"/> Base Bid 1060 MOBILIZATION - (COMPLETE REMOVAL OR MODIFICATION OF EXISTING / UNDAMAGED <input type="checkbox"/> Alt.#__ GUARDRAIL) (PER PROJECT)			
REF NO.	QUANTITY	UNIT OF MEASURE	UNIT PRICE	UNIT PRICE EXTENSION (Quantity times Unit Price)
1060	5.00	EA		

DESCRIPTION:	<input type="checkbox"/> Base Bid <input type="checkbox"/> Alt.#__			
REF NO.	QUANTITY	UNIT OF MEASURE	UNIT PRICE	UNIT PRICE EXTENSION (Quantity times Unit Price)

Wording for "DESCRIPTION" is to be provided by the Owner.
 All quantities are estimated. The contractor will be paid based upon actual quantities as verified by the Owner.

PUBLIC WORKS BID INSTRUCTIONS

A. LOUISIANA CONTRACTOR'S LICENSE FOR THIS PROJECT

Must be in the following category:

Highway, Street and Bridge Construction

Each bidder shall comply with all rules and regulations of the Louisiana State Licensing Board for Contractors in accordance with existing state laws, and shall comply with the Licensing Requirements of Jefferson Parish Ordinance No. 13574, as amended a copy of which may be obtained from the Office of the Parish Clerk, Suite 6700, Jefferson Parish General Government Building, 200 Derbigny Street, Gretna, Louisiana 70053.

B. PROBABLE CONSTRUCTION RANGES AND PRICES

Range of the Probable Construction Cost for Base Bid: \$250,000 - \$500,000

Range of the Probable Construction Cost for Alternate No. 1: _____

Range of the Probable Construction Cost for Alternate No. 2: _____

Range of the Probable Construction Cost for Alternate No. 3: _____

Range of the Previous Contract Cap **\$250,000 - \$500,000**

(Public Work Maintenance Contract): _____

The purpose and intention of this invitation to bid is to afford all suppliers/contractors an equal opportunity to bid on construction, maintenance, repair, operating, services, supplies and/or equipment listed in this bid proposal. Jefferson Parish will accept one bid only from each vendor. Items bid on must meet or exceed specifications. Where brand names, make, manufacturer or stock numbers are specified, it is for the purpose of establishing certain minimum standards of quality. Bidders may submit for products of equal quality, style, type and character, provided brand names and stock numbers are specified. Complete product data may be required prior to award.

The price quoted for the work shall be stated in figures. In the event there is a difference in unit prices and totals, the unit prices shall prevail. In the event there is a difference in unit prices, written unit prices shall prevail over numerical unit prices.

The quantities listed on the bid form are prepared for comparison of bids and may be approximate. Payment to the contractor will be made in accordance with measurement and payment requirements for bid items and other requirements of the project specifications. Bid item quantities may be increased, decreased, or omitted as provided in the specifications.

Jefferson Parish requires all products to be new (current), and all work must be performed according to standard practices for the project. Unless otherwise specified, no after market parts will be accepted. Unless otherwise specified, all workmanship and materials must have at least a one (1) year guaranty, in writing, from the date of delivery/acceptance of the project.

C. MAINTENANCE, REPAIR AND SUPPLY CONTRACTS (ONLY)

In the event that the successful bidder cannot furnish a specific item or material and labor in the required time, Jefferson Parish may purchase on an emergency basis from the next lowest bidder,

or available source, until such time the successful bidder has notified Jefferson Parish in writing that their stock or labor capability has been replenished. The difference in price will be charged against the successful bidder of this contract, and evidence of purchases and prices will be provided. **Contractor by bidding this proposal acknowledges and agrees to these provisions.**

The prices quoted in bid proposals to supply labor and materials to Jefferson Parish shall include all costs necessary for the complete performance of the work in full conformity with the conditions of the Contract Documents, and shall include all licenses and permit fees and all applicable Federal, State, County or Parish, Municipal, or other taxes due by the contractor. If the Contractor is to act as the Parish's Purchasing Agent for tax exempt purposes, the Parish shall specifically state so within this bid specification.

Jefferson Parish is exempt from paying sales taxes under LSA-R.S. 47:301(8)(c). All prices for purchases by Jefferson Parish of supplies and materials shall be quoted in the unit of measure specified and unless otherwise specified, shall be exclusive of State and Parish taxes. All quotations shall be based on F.O.B. Agency warehouse, or job site, anywhere within Jefferson Parish, as designated by the Purchasing Department.

D. METHODS OF BID SUBMISSION

All bids shall be submitted electronically through Jefferson Parish's eProcurement System online at no charge via Jefferson Parish's electronic procurement page by visiting www.jeffparishbids.net. Registration and use of this site are free to Jefferson Parish vendors. Additional instructions are included in the text box highlighting electronic procurement.

Only bids properly signed (see more below) will be accepted. **NO LATE BIDS WILL BE ACCEPTED.** The name of the bidder must be legibly shown. If the bidder is an individual, their name and address should be shown. If the bidder is an entity, the name of the person given the requisite authority to submit the bid on behalf of the entity shall be shown and the address of the entity's place of business should be shown.

Evidence of agency, corporate, limited liability or partnership authority of the person submitting and signing the bid is required for submission of bid. A copy of a corporate resolution or other signature authorization shall be required for submission of the bid. Failure to include a copy of the appropriate signature authorization will result in the rejection of the bid unless bidder has complied with LSA-R.S. 38:2212(B)(5). Photostatic or font signatures shall result in the bid being rejected. However, an electronic signature as defined in LSA-R.S. 9:2602(8) is acceptable. Signature must be a secured digital signature. A sample corporate resolution and sample certification of sole proprietorship can be downloaded from the Jefferson Parish Purchasing Department's website <http://purchasing.jeffparish.net>, or you may provide your own document.

E. TIMELINES

1. Prior to the closing time for receipt of scheduled bids

A bid may be withdrawn at any time prior to the scheduled closing time for receipt of bids, provided a request in writing, executed by the bidder or his duly authorized representative, is filed with the Parish prior to that time. When such a request is received, the bid will be returned to the bidder unopened. However, no bid can be modified, corrected or withdrawn after the time set for closing such bid, except as provided by LSA-R.S. 38:2214(C) & (D).

The Parish, its engineers, architects or anyone distributing plans and specifications for Parish public work projects, equal to or over the contract limit as defined in LA-R.S. 38:2212, shall furnish all prime bidders who request bid documents and who are properly licensed by the Louisiana State Licensing Board for Contractors with at least one set of complete bid documents. A deposit or fee may be charged on the documents as authorized by LA-R.S. 38:2212.

Addenda may be issued, as authorized by LA-R.S. 38:2212 (O). All formal Addenda require written acknowledgment on the bid form by the bidder. Failure to acknowledge an Addendum on the bid form shall cause the bid to be rejected. Jefferson Parish reserves the right to award the bid to the next lowest responsive and responsible bidder in this event.

Prior to submitting a bid each bidder shall visit the site of the proposed work and fully acquaint himself with all surface and subsurface conditions as they may exist so that he may fully understand the facilities, difficulties, and restrictions attending the execution of the work under this Contract. Bidders shall also thoroughly examine and be familiar with Drawings, Specifications, and Contract Documents. The failure or omission of any bidder to receive or examine any form, instrument, drawing, or document or to visit the site and acquaint himself with conditions there existing, shall in no way relieve any bidder from any obligation with respect to his bid and the responsibility in the premises rests with him. Submission of a bid shall be considered prima facie evidence that the bidder has made such examination and is satisfied as to the conditions to be encountered in performing the work and as to requirements of the plans, project specifications, Resolution No. 138482 and Resolution No. 113646, as amended, and contract forms.

Any pre-bid test and boring data in connection with subsurface conditions which have been completed by the Parish or its engineers and furnished to the bidder shall not be considered as fully representative of subsurface conditions existing throughout the area tested nor shall they in any way be binding upon the Parish, it being understood that said data is furnished the bidder for his convenience only and the bidder shall be solely responsible for conducting his own boring explorations he deems necessary in preparing his bid. Any prospective bidder wishing to conduct boring explorations on Parish property must obtain written permission from Jefferson Parish prior to such explorations.

No claims shall be made against the Parish for additional compensation due to unforeseen subsurface conditions arising during progress of the work and which might be in variance with the Parish's pre-bid boring data.

2. Post-closing time for receipt of scheduled bids

Except as where provided by law, bidder agrees that this bid shall be legally binding and may not be withdrawn for a period of forty-five (45) calendar days after the scheduled closing time for receiving bids. In the event the Parish issues the Letter of Award (copy of adopted resolution awarding bid by Jefferson Parish Council) during this period, the bid accepted shall continue to remain binding pending execution of the Contract.

Bidder agrees to execute the ensuing Contract and will deliver applicable Bonds to secure the faithful performance thereof.

The Parish of Jefferson reserves the right to cancel this contract for convenience by issuing a thirty (30) day written notice to contractor.

F. BID REVIEW AND AWARD

1. Rejection of Bids

- a. Jefferson Parish may reject any and all bids for just cause in accordance with LA R.S. 38:2214(B). Just cause, for the purpose of the construction of public works, is defined, but is not limited to, the following circumstances:
 - (1) The public entity's unavailability of funds sufficient for the construction of the proposed public work.
 - (2) The failure of any bidder to submit a bid within an established threshold of the preconstruction estimates for that public work, as part of the bid specifications.
 - (3) A substantial change by the public entity prior to the award in the scope or design of the proposed public work.
 - (4) A determination by the public entity not to build the proposed public work within twelve months of the date for the public opening and reading of bids.
 - (5) The disqualification by the public entity of all bidders.

- b. Additionally, bids may be considered irregular and be rejected for any of the following, but is not limited to the following circumstances:
 - (1) If the bid form is on a form other than that furnished by the Parish or if the form is altered or any part thereof is detached.
 - (2) If affidavits included in bid form and/or required by law are not returned with the bid or are not properly executed and notarized.
 - (3) If there are unauthorized additions, conditional or alternate bids or irregularities which alter the general terms and conditions, the plans or specifications, or make the bid incomplete, indefinite, or ambiguous as to its meaning.
 - (4) If the bidder adds provisions reserving the right to accept or reject the award or to enter into the contract pursuant to the award.
 - (5) If an owner or a principal officer of the bidding firm is an owner or a principal officer of a firm which has been declared by the Parish to be ineligible to bid.
 - (6) If the proposed bid security does not meet the requirements of Section K.
 - (7) If more than one proposal for the same work, services, materials or supplies is received from an individual, partner, firm, corporation, joint venture, other legal entity, or combination thereof under the same or a different name.
 - (8) The bid is not properly signed or the authority of the signature person submitting the bid is deemed insufficient or unacceptable.
 - (9) If the bidder does not possess the proper license(s) required as noted in the specifications.
 - (10) Any other reasons for rejection set forth by State or Parish laws, Ordinances or Resolutions.

- c. In awarding contracts for materials and supplies, Jefferson Parish shall reject the lowest bid if received from a bidder domiciled in a Communist country, or if the materials or supplies are manufactured in a Communist country, including but not limited to China, North Korea and Vietnam, and to award the contract to the next lowest bidder. This Section shall not apply to any country having established trade relations agreements or approvals from the government of the United States. (LSA-R.S. 38:2212.3)

2. Disqualification of Bids

- a. The causes for disqualification from consideration for award of a contract with Jefferson Parish are as follows (Jefferson Parish Code of Ordinances, Section 2-912):
- (1) Conviction for commission of a criminal offense as an incident to obtaining or attempting to obtain a public or private contract or subcontract, or in the performance of such contract or subcontract;
 - (2) Conviction under state or federal statutes of embezzlement, theft, forgery, bribery, falsification or destruction of records, receiving stolen property, or any other offense indicating a lack of business integrity or business honesty which currently, seriously, and directly affects responsibility as a Parish contractor;
 - (3) Conviction under state or federal antitrust statutes arising out of the submission of bids or proposals;
 - (4) Violation of contract provisions, as set forth below, of a character which is regarded by the Purchasing Director or his designee for Jefferson Parish to be serious as to justify disqualification:
 - i. Deliberate failure without good cause to perform in accordance with the specifications or within the time limit provided in the contract; or
 - ii. A recent record of failure to perform or of unsatisfactory performance in accordance with the terms of one or more contracts; provided that failure to perform or unsatisfactory performance caused by acts beyond the control of the contractor shall not be considered to be a basis for disqualification; or
 - iii. Failure to timely pay, without cause, a subcontractor for work performed under a construction contract as required under Section 2-976 in Chapter 2, Article VII, of the Jefferson Parish Code of Ordinances, provided disqualification on such basis shall not exceed a period of one (1) year from the deadline to pay the subcontractor.
 - (5) Any other cause the Purchasing Director determines to be so serious and compelling as to affect responsibility as a Parish contractor, including debarment by another governmental entity for any cause;
 - (6) Violation of the State Code of Ethics or the ethical standards set forth in the Jefferson Parish Code of Ordinances;
 - (7) Failure to secure and/or maintain necessary licenses and/or permits;
 - (8) Failure to comply with the Jefferson Parish Code of Ordinances and/or the Jefferson Parish Comprehensive Zoning Ordinance; or failure to comply with or meet bid specifications and/or failure to be a responsible bidder.
 - (9) A bid which is not responsive to, or does not meet bid specifications, will be rejected as being non-responsive, but that bidder will not be disqualified from future Parish bids, nor will that bidder be given a hearing pursuant to procedure listed below.
- b. The procedures for disqualification from consideration for award of a contract with Jefferson Parish are set forth in Sec. 2- 912 (b).

3. Award of Contract

The award of the contract, if it be awarded, will be by the Parish to the lowest responsive and responsible bidder whose proposal shall have complied with all the bid requirements. The successful bidder will be notified via the e-Procurement site that his bid has been accepted. No contract shall be executed with any contractor until their certificates of insurance, performance bonds, labor and materials payment bonds, or any other bonds required are made satisfactory to the Parish.

Jefferson Parish reserves the right to award contracts or place orders on a lump sum or individual item basis, or such combination as shall, in its judgment, be in the best interest of Jefferson Parish. Every contract or order shall be awarded to the lowest responsible bidder, taking into consideration the conformity with the specifications, and the delivery and/or completion date.

Preference will be given to bidders requesting a preference in their bid in accordance with LSA-R.S. 38:2251-2261 for materials, supplies, and provisions, produced, manufactured or grown in Louisiana, quality being equal to articles offered by competitors outside the State of Louisiana, unless federal funding is directly spent by Jefferson Parish on this project.

The successful bidder shall execute the contract with the Parish in the form of the contract included in the specifications, a copy of which is annexed hereto, in such number of counterparts as the Parish may request within twelve (12) days after receipt of notice of award of the contract by the Parish. One copy of the executed contract with all documents forming a part thereof shall be filed at the expense of the contractor, with the Recorder of Mortgages in Jefferson Parish.

PROTESTS: Only those vendors that submit bids in response to this solicitation may protest any element of the procurement, in writing to the Director of the Purchasing Department. Written protest must be received within 48 hours of the release of the bid tabulation by the Purchasing Department. After consultation, the Parish Attorney's Office will then respond to protests in writing. (For more information, please see Chapter 2, Article VII, Division 2, Sec. 2-913 of the Jefferson Parish Code of Ordinances.)

Upon full execution of the contract and receiving a written notice to proceed, the bidder agrees that all work shall be completed as follows:

<p>The work shall be substantially complete within ____ calendar days of the written notice to proceed and completed and shall be ready for final acceptance no more than 30 calendar days after substantial completion.</p>

G. SALES TAX EXEMPTION

For this project, the contractor shall not pay any state or local sales or use taxes on materials and equipment which are affixed and made part of the immovable property of the project or which is permanently incorporated in the project (hereinafter referred to as "applicable materials and equipment"). All purchases of applicable materials or equipment shall be made by the contractor on behalf of and as the agent of Jefferson Parish (Parish), a political subdivision of the State of Louisiana. No state and local sales and use taxes are owed on applicable materials and equipment under the provisions of Act 1029 of the 1991 Regular Session – Louisiana Revised Statute 47:301(8)(c). Parish will furnish to contractor a certificate form which certifies that Parish is not required to pay such state or local sales and use taxes, and contractor shall furnish a copy of such certificate to all vendors or suppliers of the applicable materials and equipment, and report to Parish the amount of taxes not incurred.

H. LIQUIDATED DAMAGES

In accordance with Resolution No. 113646, as amended, and Resolution No. 138482, Bidder agrees to pay, as liquidated damages, the sum of \$_____ for: (1) each consecutive calendar day after the agreed date of substantial completion that the work remains substantially incomplete, and (2) each consecutive calendar day after the 30th day following the actual date of substantial completion that the work has not been finally completed.

In addition to, but not in lieu of the per diem liquidated damages, Parish shall also be entitled to recover from the contractor or the contractor's surety additional liquidated damages as detailed in Resolution No. 113646, as amended, and Resolution No. 138482. These additional liquidated damages may include, but are not limited to the following, in the amounts and for each of the items identified in the Supplementary Conditions:

- (1) Extended Architectural and/or Engineering Fees \$ _____ /hour
- (2) Extended Resident Project Representative Fee \$ _____ /hour
- (3) Extended Construction Management Fees \$ _____ /day
- (4) Extended Parish's Overhead and Personnel Expenses \$ _____ /hour
- (5) Parish's Other Costs Directly Related to the Delay in Completion Beyond the Contract Times.

Whenever contractor's work requires inspections in excess of the budgeted amount for inspection, the contractor shall reimburse the Parish for the additional costs incurred by the Parish attributable to inspection of the contracted project in excess of the budgeted amount for inspections.

The reasonable budget for such inspections is \$ _____. Resident Project Representative overtime rates shall be calculated at 1.2 times the hourly rate. The cost of inspection in excess of this budgeted amount shall be assessed against Contractor's progress payments, all in accordance with Louisiana Public Bid Law.

I. ETHICAL STANDARDS AND COOPERATION WITH THE OFFICE OF THE INSPECTOR GENERAL, INCLUDING CONFLICTS OF INTEREST

Vendor agrees by bid submission to comply with all provisions of Louisiana Law as well as compliance with the Jefferson Parish Code of Ordinances, Louisiana Code of Ethics, as published on <http://ethics.la.gov> and applicable Jefferson Parish ethical standards and Jefferson Parish Terms and Conditions.

Inspector General: It shall be the duty of every Parish officer, employee, department, agency, special district, board, and commission; and the duty of every contractor, subcontractor, and licensee of the Parish, and the duty of every applicant for certification of eligibility for a Parish contract or program, to cooperate with the Inspector General in any investigation, audit, inspection, performance review, or hearing pursuant to JPCO 2-155.10(19). Every Parish contract and every bid, proposal, application or solicitation for a Parish contract, and every application for certification of eligibility for a Parish contract or program shall contain a statement that the corporation, partnership, or person understands and will abide by all provisions of JPCO 2-155.10. By submitting a bid, Bidder acknowledges this and will abide by all provisions of the referenced JPCO.

Conflicts of Interest: Jefferson Parish adheres to the Louisiana Code of Governmental Ethics, contained in Louisiana Revised Statutes Annotated, R.S. 42:1101, et seq. Vendor/Proposer by this submission warrants that there are no "conflicts of interest" related to this procurement that would violate applicable Louisiana Law. Violation of the Louisiana Code of Governmental Ethics may result in rescission of contract, permit or licenses, and the imposition of fines and/or penalties, without contractual liability to the public in accordance with applicable law.

J. REQUIRED AFFIDAVITS

For convenience, all legally mandated affidavits have been combined into one form, entitled **Public Works Bid Affidavit**. All bidders must submit with their bid submission, a completed, signed and properly notarized affidavit in its original format and without alteration in order to be compliant and for the bid to be considered responsive. A scanned copy of the completed, signed and properly notarized affidavit may be submitted with the bid; however, the successful bidder must submit the original affidavit in its original format and without material alteration prior to, or at contract execution. Failure to comply will result in the bid submission being rejected as non-responsive. The Parish reserves the right to award bid to the next lowest responsive and responsible bidder in this event.

The person submitting the bid, and whose authority to submit has been evidenced on the Corporate Resolution is the proper party to execute the **Public Works Bid Affidavit**.

K. BID REQUIREMENTS (BID DOCUMENTS, SPECIFICATIONS, BONDS, W-9 AND PAYMENT INFO)

Bidders must review the bid specifications and include any required documentation including but not limited to the LA Public Works Uniform Bid Form, Bid Security, Corporate Resolution or written evidence of signature authority, and the Public Works Affidavit. Pursuant to LA R.S. 38:2212(B)(3)(b), bidders shall also be responsible for providing any other documentation as required, i.e. federal grant documentation, etc. Please note that the payment and performance bonds must be supplied by the successful bidder at contract signing.

No oral interpretation will be made to any bidder as to the meaning of the drawings, specifications, or contract documents. Every request for such interpretation shall be made in writing and addressed and forwarded to the Engineer, Architect or person distributing plans and specifications. No inquiry received within five (5) days prior to the day fixed for opening of the bids will be given consideration. Every interpretation made to the bidder shall be in the form of an addendum to the specifications and shall be issued as authorized by LA-R.S. 38:2212(O).

All such addenda shall become a part of the contract documents. Failure of any bidder to receive any such interpretation shall not relieve any bidder from any obligation under his bid as submitted without modification.

The specifications and plans are complementary of each other and all work called for or reasonably implied by either shall be performed as if called for by both. In case of conflict between the requirements of the specifications and plans, the specifications shall take precedence. Figured dimensions shall take precedence over scale dimensions, and larger scale details shall take precedence over smaller scale details in the general work drawings.

All vendors submitting bids shall register as a Jefferson Parish vendor, if not already registered. Registration forms may be downloaded from <http://purchasing.jeffparish.net> and click on Vendor Information. Current W-9 forms with respective Tax Identification numbers and vendor applications may be submitted at any time; however, if your company is not registered and/or a current W-9 form is not on file, vendor registration is mandatory. Vendors may experience a delay in payment if your company is not a registered vendor with Jefferson Parish.

Bidders must comply with all provisions of this Notice, the Standard General Conditions of the Construction Contract and any special conditions and specifications contained herein, all of which are made part of this bid proposal. Resolution No. 113646, as amended, and Resolution No. 138482 will be considered a part of the bid whether attached or not. A copy of these terms and resolutions may be obtained from the Office of the Parish Clerk, Suite 6700, Jefferson Parish General Government Building, 200 Derbigny Street, Gretna, Louisiana 70053. Bidders may also obtain a copy by visiting the Purchasing Department's webpage at <http://purchasing.jeffparish.net> and clicking on online forms.

Bid Security: Bidders shall provide bid security in the form of an electronic bid bond in the amount of five percent (5%) of the total bid price (Base Bid and any Alternates) (as per R.S. 38:2218). The Bid Security shall remain valid until the contract is executed or until final disposition is made of the bids submitted. Such security will become the property of the Parish in the event the successful bidder fails or refuses to execute the contract or fails to produce performance and payment bonds upon contract signing. Bids shall remain binding for at least forty-five (45) days after the date set for the Bid Opening. In the event the Parish issues the Letter of Award during this period, the bid accepted shall continue to remain binding until the execution of contract. Jefferson Parish and the lowest responsible bidder, by mutual written consent, may agree to extend the deadline for award by one or more extensions of thirty (30) calendar days.

When submitting online, bidders must submit an electronic bid bond through the respective online clearinghouse bond management system(s) as indicated in the electronic bid solicitation on Central Auction House. No scanned paper copies of any bid bond will be accepted as part of the electronic bid submission.

Performance Bond: A performance bond is required in 100% of the contract amount and is due at the signing of the formal contract, unless another percentage is required in the bid specifications. In the event of a conflict between these instructions and the bid specifications, the bid specifications shall control.

Payment Bond: A payment bond is required in 100% of the contract amount and is due at the signing of the formal contract, unless another percentage is required in the bid specifications. In the event of a conflict between these instructions and the bid specifications, the bid specifications shall control.

To the extent permitted by law, the bond requirements as set forth herein are waived insofar as Community Development Housing Rehabilitation Construction Contracts are concerned for single family, owner-occupied dwellings. The Parish Attorney's Office will omit the requirements in connection with Community Development Housing Rehabilitation Construction Contracts for single family, owner-occupied dwellings.

L. INSURANCE REQUIREMENTS

All bidders must submit with bid submission a current (valid) insurance certificate evidencing required coverages. Failure to comply will cause the bid to be rejected. The current insurance certificate will be used for proof of insurance at time of evaluation. Thereafter, and prior to contract execution, the low bidder will be required to provide final insurance certificates to the Parish which shall name the **Jefferson Parish, its Districts, Departments and Agencies under the direction of the Parish President and the Parish Council** as additional insureds regarding negligence by the contractor for the Commercial General Liability and the Comprehensive Automobile Liability policies. **Additionally, said certificates should reflect the name of the Parish**

Department receiving goods and services and reference the respective Jefferson Parish bid number.

JEFFERSON PARISH REQUIRED STANDARD INSURANCE

WORKER'S COMPENSATION INSURANCE

As required by Louisiana State Statute, exception; Employer's Liability, Section B shall be \$1,000,000 per occurrence when Work is to be over water and involves maritime exposures to cover all employees not covered under the State Worker's Compensation Act, otherwise this limit shall be no less than \$500,000 per occurrence.

COMMERCIAL GENERAL LIABILITY

Shall provide limits not less than the following: \$1,000,000 Combined Single Limit per Occurrence for bodily injury and property damage.

COMPREHENSIVE AUTOMOBILE LIABILITY

Bodily injury liability \$1,000,000 each person; \$1,000,000 each occurrence. Property Damage Liability \$1,000,000 each occurrence.

UMBRELLA LIABILITY COVERAGE

An umbrella policy or excess may be used to meet minimum requirements.

FOR CONSTRUCTION AND RENOVATION PROJECTS:

The following are required if selected. Such insurance is due upon contract execution.

OWNER'S PROTECTIVE LIABILITY

To be for the same limits of liability for bodily injury and property damage liability established for commercial general liability.

BUILDER'S RISK INSURANCE

The contractor shall maintain Builder's Risk Insurance at his own expense to insure both the Parish of Jefferson and contractor as their interest may appear.

INSURANCE DEDUCTIBLES - The Parish Attorney with concurrence of the Director of Risk Management have waived the deductible section of the Terms and Conditions for all Invitations to Bid, until further notice.

M. INDEMNIFICATION

Bidder acknowledges that bidder recovered the cost of any required insurance in the contract price as required by LA R.S. 9:2780.1(I) and that bidder recovered any such cost for the purposes of insuring an obligation to indemnify Jefferson Parish, defend Jefferson Parish, or hold Jefferson

Parish harmless and that bidder's indemnity liability is limited to the amount of the proceeds that are payable under the insurance policy or policies that bidder has obtained.

N. FAMILIARITY WITH LAWS AND ORDINANCES

Bidders shall familiarize themselves with and shall comply with all applicable Federal and State Laws, Parish/Municipal Ordinances, Resolutions, and the rules and regulations of all authorities having jurisdiction over construction of the project, which may directly or indirectly affect the work or its prosecution.

These laws and/or ordinances will be deemed to be included in the contract, the same as though herein written in full.

In case of conflict between the requirements of these specifications and any State and/or Federal Regulations or Laws, the State and/or Federal Regulations or Laws shall take precedence in all cases in which State and/or Federal Funding of the contract, in whole or in part, depends upon compliance with said State and/or Federal Regulations or Laws.

O. MISCELLANEOUS

The successful bidder may be required to furnish a statement of the origin, composition, and manufacture of materials to be used in construction of the work together with samples, which samples may be subjected to testing to determine their quality and fitness for the work, as specified.

Bidders are not to exclude from participation in, deny the benefits of, or subject to discrimination under any program or activity, any person in the United States on the grounds of race, color, national origin, sex or religion except that any exemption from such prohibition against discrimination on the basis of religion as provided in the Civil Rights Acts of 1964, or Title VI and VII of the Act of April 11, 1968 shall also apply, as amended; nor discriminate on the basis of age under the Age Discrimination Act of 1975, as amended; nor with respect to an otherwise qualified handicapped individual as provided in Section 504 of the Rehabilitation Act of 1973, as amended. This assurance includes compliance with the administrative requirements of the Revenue Sharing final handicapped discrimination provisions contained in Section 51.55 (c), (d), (e), and (k) (5) of the Regulations.

Non-negotiable contract terms include but are not limited to taxes, assignment of contract, audit of records, EEOC and ADA compliance, record retention, content of contract/order of precedence, contract changes, force majeure, governing law, including ethics statements, claims or controversies, and termination based on contingency of appropriation of funds, as applicable.

Bid Bond

An Electronic Bid Bond must be submitted with this bid, through one of the respective clearing houses at www.jeffparish.net or www.centralbidding.com. To access the bonding companies on Central Bidding, hover over the "Central Bidding" link at the top of the page and select the "Bid Bonds" link.

The electronic bid bond number is to be placed in the required section listed on the standard envelope. Scanned copies of bid bonds will not be accepted with your submission.

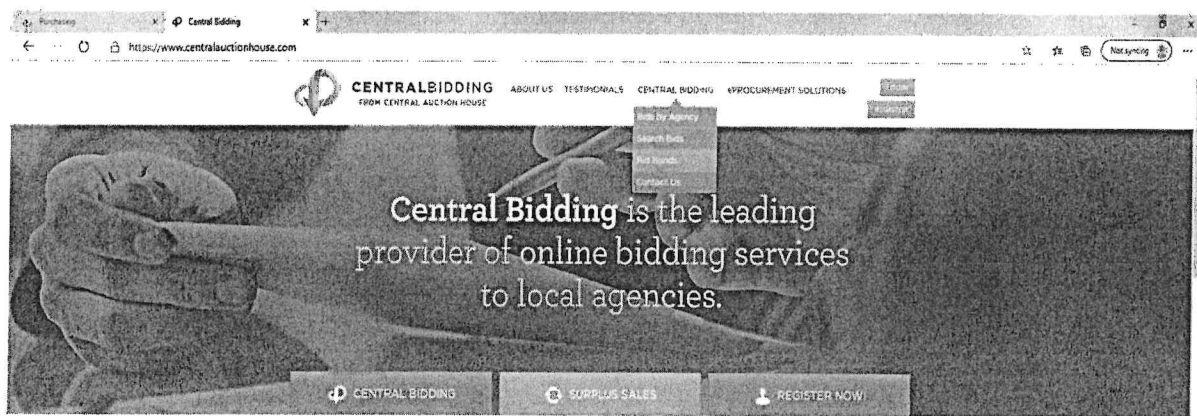

\$41.6 Billion

38,136 Bid Opportunities

18,123 Vendors

568 Agencies

Browse Thousands of Public Bids today!

Central Bidding, founded in 2007, is one of the largest providers of electronic bidding services to public and private buying entities. Vendors have trusted Central Bidding to securely deliver more than \$41.6 Billion worth of electronic bids for more than 450 buying entities since their founding. Central Bidding works under exclusive contract with each of these buying entities and in each instance Central Bidding is the only official electronic location to receive the bid documents, the automated updates and a list of electronic bids.

[Learn More >](#)

Public Works Bid Affidavit Instructions

- **Affidavit is supplied as a courtesy to Affiants, but it is the responsibility of the affiant to insure the affidavit they submit to Jefferson Parish complies, in both form and content, with federal, state and parish laws.**
- **Affidavit must be signed by an authorized representative of the entity or the affidavit will not be accepted.**
- **Affidavit must be notarized or the affidavit will not be accepted.**
- **Notary must sign name, print name, and include bar/notary number, or the affidavit will not be accepted.**
- **Affiant MUST select either A or B when required or the affidavit will not be accepted.**
- **Affiants who select choice A must include an attachment or the affidavit will not be accepted.**
- **If both choice A and B are selected, the affidavit will not be accepted.**
- **Affidavit marked N/A will not be accepted.**
- **It is the responsibility of the Affiant to submit a new affidavit if any additional campaign contributions are made after the affidavit is executed but prior to the time the council acts on the matter.**

Instruction sheet may be omitted when submitting the affidavit

Public Works Bid

AFFIDAVIT

STATE OF _____

PARISH/COUNTY OF _____

BEFORE ME, the undersigned authority, personally came and appeared: _____
_____, (Affiant) who after being by me duly sworn, deposed and said that
he/she is the fully authorized _____ of _____ (Entity),
the party who submitted a bid in response to Bid Number _____, to the Parish of
Jefferson.

Affiant further said:

Campaign Contribution Disclosures

(Choose A or B, if option A is indicated please include the required attachment):

Choice A _____ Attached hereto is a list of all campaign contributions, including the date and amount of each contribution, made to current or former elected officials of the Parish of Jefferson by Entity, Affiant, and/or officers, directors and owners, including employees, owning 25% or more of the Entity during the two-year period immediately preceding the date of this affidavit or the current term of the elected official, whichever is greater. Further, Entity, Affiant, and/or Entity Owners have not made any contributions to or in support of current or former members of the Jefferson Parish Council or the Jefferson Parish President through or in the name of another person or legal entity, either directly or indirectly.

Choice B _____ there are **NO** campaign contributions made which would require disclosure under Choice A of this section.

Affiant further said:

Debt Disclosures

(Choose A or B, if option A is indicated please include the required attachment):

Choice A _____ Attached hereto is a list of all debts owed by the affiant to any elected or appointed official of the Parish of Jefferson, and any and all debts owed by any elected or appointed official of the parish to the Affiant.

Choice B _____ There are NO debts which would require disclosure under Choice A of this section.

Affiant further said:

That Affiant has employed no person, corporation, firm, association, or other organization, either directly or indirectly, to secure the public contract under which he received payment, other than persons regularly employed by the Affiant whose services in connection with the construction, alteration or demolition of the public building or project or in securing the public contract were in the regular course of their duties for Affiant; and

That no part of the contract price received by Affiant was paid or will be paid to any person, corporation, firm, association, or other organization for soliciting the contract, other than the payment of their normal compensation to persons regularly employed by the Affiant whose services in connection with the construction, alteration or demolition of the public building or project were in the regular course of their duties for Affiant.

Affiant further said:

Affiant personally has not been convicted of, nor has he/she entered into a plea of guilty or nolo contendere to any of the crimes or equivalent federal crimes listed below. No individual partner, incorporator, director, manager, officer, organizer, or member, who has a minimum of a ten percent ownership in the Bidding Entity, has been convicted of, or has entered a plea of guilty or nolo contendere to any of the crimes or equivalent federal crimes listed below. A conviction of or plea of guilty or nolo contendere to the following state crimes or equivalent federal crimes shall permanently bar any person or the bidding entity from bidding on public projects:

- (a) Public bribery (R.S. 14:118)
- (b) Corrupt influencing (R.S. 14:120)
- (c) Extortion (R.S. 14:66)
- (d) Money laundering (R.S. 14:230)

A conviction of or plea of guilty or nolo contendere to the following state crimes or equivalent federal crimes shall bar any person or the bidding entity from bidding on public projects for a period of five years from the date of conviction or from the date of the entrance of the plea of guilty or nolo contendere:

- (a) Theft (R.S. 14:67)
- (b) Identity Theft (R.S. 14:67, 16)
- (c) Theft of a business record (R.S. 14:67.20)
- (d) False accounting (R.S. 14:70)
- (e) Issuing worthless checks (R.S. 14:71)
- (f) Bank fraud (R.S. 14:71.1)
- (g) Forgery (R.S. 14:72)
- (h) Contractors; misapplication of payments (R.S. 14:202)
- (i) Malfeasance in office (R.S. 14:134)

The five-year prohibition provided for in this section shall apply only if the crime was committed during the solicitation or execution of a contract or bid awarded pursuant to these provisions. If evidence is submitted substantiating that a false attestation has been made and the project must be readvertised or the contract cancelled, the awarded entity making the false attestation shall be responsible to the public entity for the costs of rebidding, additional costs due to increased costs of bids and any and all delay costs due to the rebid or cancellation of this project.

[The remainder of this page is intentionally left blank.]

Affiant further said:

- (1) Entity is registered and participates in a status verification system to verify that all employees in the State of Louisiana are legal citizens of the United States or are legal aliens.
- (2) Entity shall continue, during the term of the contract, to utilize a status verification system to verify the legal status of all new employees in the State of Louisiana.
- (3) Entity shall require all subcontractors to submit to the Entity a sworn affidavit verifying compliance with statements (1) and (2).

Signature of Affiant

Printed Name of Affiant

SWORN AND SUBSCRIBED TO BEFORE ME

ON THE _____ DAY OF _____, 20__.

Notary Public

Printed Name of Notary

Notary/Bar Roll Number

My commission expires _____.



**Designation of Construction Contractor
as Agent of a Governmental Entity
Sales Tax Exemption Certificate**

_____, an agency of the United States government, or an agency, board, commission, or instrumentality of the State of Louisiana or its political subdivisions, including parishes, municipalities and school boards, does hereby designate the following contractor as its agent for the purpose of making sales tax exempt purchases on behalf of the governmental body:

Name of Contractor		
Address		
City	State	ZIP

This designation of agency shall be effective for purchases of component construction materials, taxable services and leases and rentals of tangible personal property for the following named construction project:

Construction Project	Contract Number
----------------------	-----------------

This designation and acceptance of agency is effective for the period

Beginning Date (mm/dd/yyyy)	End Date (mm/dd/yyyy)
-----------------------------	-----------------------

Purchases for the named project during this period by the designated contractor shall be considered as the legal equivalent of purchases directly by the governmental body. Any materials purchased by this agent shall immediately, upon the vendor's delivery to the agent, become the property of this government entity. This government entity, as principal, assumes direct liability to the vendor for the payment of any property, services, leases, or rentals made by this designated agent. This agreement does not void or supersede the obligations of any party created under any construction contract related to this project, including specifically any contractual obligation of the construction contractor to submit payment to the vendors of materials or services for the project.

This contractor-agent is not authorized to delegate this purchasing agency to others; separate designations of agency by this governmental entity are required for each contractor or sub-contractor who is to purchase on behalf of this governmental entity. The undersigned hereby certify that this designation is the entirety of the agency designation agreement between them. In order for a purchase for an eligible governmental entity through a designated agent to be eligible for sales tax exemption, the designation of agency must be made, accepted, and disclosed to the vendor before or at the time of the purchase transaction.

Designation of Agency			Acceptance of Agency		
Signature of Authorized Designator	Date (mm/dd/yyyy)		Signature of Contractor or Subcontractor Authorized Acceptor	Date (mm/dd/yyyy)	
Name of Authorized Designator			Name of Contractor's or Subcontractor's Acceptor		
Name of Governmental Entity			Name of Contractor		
Address			Address		
City	State	ZIP	City	State	ZIP

This designation of agency form, when properly executed by both the contractor and the governmental entity, shall serve as evidence of the sales tax exempt status that has been conferred onto the contractor. No other exemption certificate form is necessary to claim exemption from sales taxes. The agency agreement evidenced by this sales tax exemption certificate must be implemented at the time of contract execution with the governmental entity. The contract between the governmental entity and his agent must contain provisions to authenticate the conferment of agency.

CORPORATE RESOLUTION

EXCERPT FROM MINUTES OF MEETING OF THE BOARD OF DIRECTORS OF

INCORPORATED.

AT THE MEETING OF DIRECTORS OF _____
INCORPORATED, DULY NOTICED AND HELD ON _____,
A QUORUM BEING THERE PRESENT, ON MOTION DULY MADE AND SECONDED. IT
WAS:

RESOLVED THAT _____, BE AND IS HEREBY
APPOINTED, CONSTITUTED AND DESIGNATED AS AGENT AND ATTORNEY-IN-
FACT OF THE CORPORATION WITH FULL POWER AND AUTHORITY TO ACT ON
BEHALF OF THIS CORPORATION IN ALL NEGOTIATIONS, BIDDING, CONCERNS
AND TRANSACTIONS WITH THE PARISH OF JEFFERSON OR ANY OF ITS AGENCIES,
DEPARTMENTS, EMPLOYEES OR AGENTS, INCLUDING BUT NOT LIMITED TO, THE
EXECUTION OF ALL BIDS, PAPERS, DOCUMENTS, AFFIDAVITS, BONDS, SURETIES,
CONTRACTS AND ACTS AND TO RECEIVE ALL PURCHASE ORDERS AND NOTICES
ISSUED PURSUANT TO THE PROVISIONS OF ANY SUCH BID OR CONTRACT, THIS
CORPORATION HEREBY RATIFYING, APPROVING, CONFIRMING, AND ACCEPTING
EACH AND EVERY SUCH ACT PERFORMED BY SAID AGENT AND ATTORNEY-IN-
FACT.

I HEREBY CERTIFY THE FOREGOING TO BE
A TRUE AND CORRECT COPY OF AN
EXCERPT OF THE MINUTES OF THE ABOVE
DATED MEETING OF THE BOARD OF
DIRECTORS OF SAID CORPORATION, AND
THE SAME HAS NOT BEEN REVOKED OR
RESCINDED.

SECRETARY-TREASURER

DATE

GUARDRAIL MAINTENANCE

Two (2) year contract for guardrail maintenance (removal, installation and repair) for the Jefferson Parish Department of Public Works – Streets and all Jefferson Parish agencies and municipalities, (Grand Isle addressed with specific items).

PRE-BID CONFERENCE:

All prospective bidders are invited to attend this non-mandatory pre-bid conference, which will be held at General Government Building, 200 Derbigny St. Suite 4400, Gretna, La 70053 on July 28, 2023 at 10:00 a.m.. However, failure to attend the pre-bid conference shall not relieve the bidder of responsibility for information discussed at the conference. Furthermore, failure to attend the pre-bid conference and inspection does not relieve the successful bidder from the necessity of furnishing materials or performing any work that may be required to complete the work in accordance with the specification with no additional cost to the owner.

LOUISIANA STATE CONTRACTOR'S LICENSE:

Highway, Street and Bridge Construction:

Subclass: Permanent or paved highways and streets (asphalt surface treatment)

NOTE – Submitting the bid electronically, the license number must be entered in the appropriate field in the Electronic Procurement System. Failure to comply will cause the bid to be rejected.

SURETY BID BOND:

BID BOND:

A bid bond in the amount of five (5%) of the bid is due with the bid submission. Vendor must submit an electronic bid bond through the respective online clearinghouse bond management system as indicated in the electronic bid solicitation on Central Auction House. No scanned paper copies of any bid bond will be accepted as part of the electronic bid submission.

PERFORMANCE BOND:

A performance bond in the amount of 50% of the total bid is required.

PAYMENT BOND:

A payment bond in the amount of 50% of the total bid is required.

ATTACHMENTS TO BE INCLUDED WITH THIS BID: See pages 9 thru 12.

- A. QUADGUARD SYSTEM DRAWINGS, 2 PAGES (ITEMS 0640 & 0650, 0660-0790 for repair items)**
- B. YODOCK 2001M (WATER) FILLABLE BARICADE, 2 PAGES (ITEMS 0940 & 0945)**

GENERAL SPECIFICATIONS:

1. All materials and methods of installation to comply with the Louisiana Department of Transportation and Development's "Standard Specifications for Roads and Bridges" 2016 Edition and G.R. 200 Standard Plan for Guardrail.
2. Jefferson Parish to install object markers with posts at guardrail locations.
3. Jefferson Parish will notify contractor of delivery location for all salvaged guardrail materials. If Jefferson Parish does not want salvaged materials, the contractor must dispose of same in proper fashion. Delivery and/or disposal of salvaged materials is at no direct pay with the exception of concrete guardrail posts (see bid item).

If required, a layout plan for each job shall be provided by this department.

All layout and placement shall be the responsibility of the vendor.

All of the work within the limits of each job shall be shown to the contractor by a representative of the Department of Public Works prior to commencing work. Appropriate sketches and/or drawings may be furnished to the contractor with each work order. Work site may be scattered for an individual work order; however, every effort will be made to consolidate the work to minimize scattered work sites.

Each work order will be issued in letter form with appropriate drawings or other attachments as necessary and will designate a job number (WO#00-00000). All correspondence, billing, etc., pertaining to the work should reference this job number designation, the contract estimate and WO numbers. Payment will be made upon receipt of detailed and itemized invoices and verification by public works inspectors regarding quantity and quality of work performed. Partial payments will be made only when completion is unduly delayed through no fault of the contractor, in which case requests for partial payment may be submitted monthly.

For this proposal, the definition of "JOB" shall be the work described on any one issued work order.

The contractor will be required during the term of this contract to respond to verbal notification, that a guardrail location has been damaged and services are required. Within one (1) week of notification the contractor shall file a damage report listing the items proposed for replacement or repair at the site with the project engineer. The project engineer will review the specific items of work and issue a written work order stating the specific location or locations and authorizing the contractor to begin work. The work order will also specify replacement of damaged parts or furnish and replace damaged parts. The contractor shall begin the work within ten (10) days after the issuance of a work order. The contractor will complete all work at a site within five (5) working days from the time he shows up on site. Failure to begin or complete the work within the time specified will result in the assessment of stipulated damages (\$250.00/day).

If any liens are filed during execution of this contract, the parish shall withhold the next accruing payment and shall have the authority to satisfy the claim and deduct the amount from payments due.

If any liens arising out of this contract should be discovered to exist after all payments are made, the contractor shall refund the parish all monies that the latter may be compelled to pay in discharging such liens, including litigation costs and attorney's fees.

Adequate safety precaution will be taken for all work performed under this contract. Necessary barricades, signs, lights and warning devices will be installed and maintained by the contractor. The contractor shall be responsible for providing safe and expeditious movement of traffic through construction zones, i.e., the immediate area of actual construction and all abutting areas which are used by the contractor and which interfere with the driving and walking public. The responsibility includes, but is not limited to such items as proper construction warning signing, signals, lighting devices, markings, barricades, channelization and hand signaling devices (flagging operations). The principal and prescribed standards are set forth in Part VI of the Manual on Uniform Traffic Control Devices. Part VI should be strictly followed.

All of the signing and traffic control devices shall be approved by the Office of Traffic Engineering, Jefferson Parish Department of Public Works prior to starting of the job. All expenses related to maintain traffic is incidental to the job. There is no added or additional payment.

During the performance of all work as outlined in these specifications, the contractor will exercise due caution regarding underground utilities, storm water drainage pipe and will cooperate with representatives of the respective utility companies and/or parish departments to avoid damage to their installations. The contractor will be required to restore at his own expense or reimburse the parish for the cost to repair any parish infrastructure that he damages.

The contractor must protect, support and maintain all subsurface, surface and aerial utilities. In the event of any damage to the existing utilities, contractor shall restore service, as soon as possible at his own expense. The contractor shall have the sole responsibility of resolving any lawsuits and liabilities arising from defective workmanship and/or improper maintenance of utilities.

It is understood by the undersigned that the quantities given in the schedule of bid prices are a fair approximation of the amount of work to be done and that the sum of the products of the approximate quantities multiplied by the unit price bid constitute the base bid price, which sum shall be used in the comparison of bids and the awarding of the respective contracts.

The quantities given in the proposal form are approximate for the comparison of bids only. The parish reserves the right to purchase only such items and in such quantities as needed for initial period of two (2) years after acceptance of the lowest responsible bid by the parish governing authority.

THE FOLLOWING SPECIFICATIONS WILL APPLY TO ITEM 0010 thru 0630:

All guardrail materials including but not limited to metal rail elements, metal & timber posts, block-outs, end treatments, anchor sections, attenuators, and all associated hardware (wire rope and fittings included) shall conform to the 2016 Edition of the Louisiana Standard Specifications for Roads and Bridges under "GUARDRAIL" (Section 704, and associated subsections). In addition, all materials used shall be listed within the Louisiana Department of Transportation and Development "Approved Materials List" for Highway Guardrail.

THE FOLLOWING SPECIFICATIONS WILL APPLY TO ITEM 0640 and 0650:

Quadguard M10 MASH Crash cushion for 13 ft (TL-2) & 22 ft (TL-3)

The QuadGuard M10 is a redirective, non-gating crash cushion that consists of an engineered steel nose and crushable, energy absorbing cartridges surrounded by a framework of steel Quad-Beam panels. The system is tested to the Manual for Assessing Safety Hardware (MASH) Test Level 3 and Test Level 2.

THE FOLLOWING SPECIFICATIONS WILL APPLY TO ITEM 0880:

This item is to be used only when removal of existing guardrail is required without any replacement of guardrail. Contractor will not be paid under this item when removal and replacement takes place under normal repairs to damaged guardrails. [12.5 feet sections of guardrail equals one unit (each)].

THE FOLLOWING SPECIFICATIONS WILL APPLY TO ITEM 0930:

Davidson traffic control high density polyethylene plastic 8 feet Type III barricade (Model T3B or approved equal) to include:

- A. Three (each) 8 feet polycomb panels
- B. Type 9 prismatic hi (VIP DG) orange and white sheeting applied diagonally across the panels at 45-degree angles (left or right)
- C. Two (each) X-tube 1.75 inches square plastic 5 feet uprights
- D. Two (each) 2 inches 14 gallons PSST barricade feet with 6 inches welded upright
- E. Twelve (each) bolts and nylock nuts (for panel attachment)
- F. Two (each) quick-release pins (for barricade feet)

THE FOLLOWING SPECIFICATIONS WILL APPLY TO ITEM 0940 and 0945:

Yodock Model 2001M plastic portable barrier or approved equal. The barriers shall have the following dimensions:

- A. Height: 32 inches
- B. Base Width: 18 inches
- C. Functional Length: 72 inches
- D. The barrier shall be constructed of Low Density Polyethylene (LDPE) .
- E. Standard colors shall be orange and opaque ivory.
- F. Each barrier shall weigh approximately 75 pounds empty and up to approximately 750 pounds when filled with water.
- G. Barriers shall have the ability to be interlocked when installed.

THE FOLLOWING SPECIFICATIONS WILL APPLY TO ITEMS 0900 thru 0942:

Items 0900 thru 0942 are for emergency use only.

These items are not for the everyday traffic control usage that the contractor must use to do his work. This is for prolonged, unforeseen, emergency circumstances that may require lane closures for prolonged periods of time.

The amount of each item and layout of each item will be as directed by Jefferson Parish Traffic Engineering or the Department of Streets.

THE FOLLOWING SPECIFICATIONS WILL APPLY TO ITEMS 0945 and 0947:

This item will be used if the parish wished to purchase said items.

THE FOLLOWING SPECIFICATIONS WILL APPLY TO ITEMS 0950 THRU 0960:

Remove and dispose of existing pavement (asphalt/concrete/ etc.) for the thickness as shown. Curbing removed (if applicable) with the pavement will be at no additional cost. Should the parish desire, the contractor will deliver the materials at the disposal site designated by the parish at no added cost, provided that the disposal (dumping) site is within a 21-mile radius of the work site and may involve crossing the Mississippi River. Additionally, should the parish desire, the contractor will load broken pavement onto parish trucks at the work site at no added cost, provided that the parish trucks are present at the work site for loading as the pavement is being removed and do not unduly delay the contractor's work.

Care must be exercised so that jointing materials and devices adjacent to the pavement to be removed shall not be damaged. Any pavement damaged by the contractor as a result of negligence, either willful or accidental, will be replaced at the contractor's expense.

THE FOLLOWING SPECIFICATIONS WILL APPLY TO ITEMS 0970 THRU 0980:

4000 PSI – 72 Hours – High early strength with superplasticizer and other additives, if applicable.

This item covers the furnishing of all materials and installation of PCC pavements for thickness as shown. Concrete shall be Class A, 4000 PSI 72 hours high early strength. The mix shall conform to Louisiana Department of Transportation and Development Standard Specifications for Roads and Bridges, Latest Edition.

THE FOLLOWING SPECIFICATIONS WILL APPLY TO ITEMS 0990 THRU 1000:

Excavation will be paid by cubic yard truck measure loaded at the job sites or by computing theoretical volume at the approval of the parish representative. Should the parish desire, the contractor will dump excavated materials at a disposal site designated by the parish at no added cost, provided that the disposal (dumping) site is within a 21-mile radius of the work site and may involve crossing the Mississippi River. Additionally, should the parish desire, the contractor will load excavated material onto parish trucks at the work site at no added cost provided that the parish trucks are present at the work site at the time of excavation and do not unduly delay the contractor's work. However, ultimate responsibility for disposal of all the excavated material rests with the contractor.

The contractor will exercise due caution regarding underground utilities during excavation operations and will notify and coordinate with representatives of utility companies and parish departments to avoid damage to their installations. However, contractor is ultimately responsible for all damages caused by his actions.

No trucks with greater load capacity than 18 cubic yards shall be allowed on residential streets for excavation, concrete/asphalt removal or fill material delivery without authorization from the engineer. Should the contractor fail to meet this condition, all damage resulting will be repaired at the contractor's expense.

THE FOLLOWING SPECIFICATIONS WILL APPLY TO ITEM 1030:

Specifications shall be in accordance with Louisiana Standard Specifications for Roads and Bridges (Latest Edition) under "STONE". In addition, material shall be calcitic or dolomitic with calcium carbonate not less than 85 percent and the silica content (impurities) not to exceed 5 percent. Limestone used on asphalt pavement shoulders shall be comparable to Mexican limestone in color and gradation.

Shoulder Aggregate

This material shall conform to the following gradation:

Limestone

U.S. Sieve	Percent Passing
1.5 inches	100
0.75 inches	50-100
No. 4	35-65
No. 40	10-32
No. 200	3-15

Aggregate shall conform to LADOTD Standard Specifications for Roads and Bridges, Subsection 1003.01, Latest Edition.

The fraction of stone passing the No. 40 sieve shall be non-plastic.

THE FOLLOWING SPECIFICATIONS WILL APPLY TO ITEM 1040:

Asphaltic Pavements

The bituminous hot mix asphalt Type III shall conform to the latest ASTM and AASHTO specifications and all workmanship, equipment and materials shall be in accordance with the LADOTD, Office of Highways, Louisiana Standard Specifications for Roads and Bridges, (2000 edition) and applicable sections. All polymer (binding and wearing) shall obtain marshal stability of 1800 lbs. minimum.

The accepted quantities of asphaltic concrete will be paid for at the contract unit price per ton (2,000 pound). The estimated quantities shown in the proposal are for Type III mix

found in Louisiana Standard Specifications for Roads and Bridges, 2000 edition and applicable sections. No other type of mix will be allowed without prior approval of the engineer (owner). Haul and/or loading tickets will be issued for each truck load of asphalt delivered by vendor's trucks and placed on the job. Tack coat or prime coat required will not be measured for separate payment, but will be considered incidental to the asphaltic concrete pay item.

THE FOLLOWING SPECIFICATIONS WILL APPLY TO ITEM 1050 THRU 1060:

This item pertains to the movement of all personnel, equipment, and supplies to a designated project site and the handling of bonds, insurance, permits and all other preconstruction paperwork in general preparation of work on a particular project.

Payment for this item shall be per each project issue. However, if any subsequent work orders are issued within a 1.5 mile radius prior to the initial work order commencing, then no additional mobilization charge will be paid on the subsequent work orders for that area. In this case, the bid item of the 3 mobilization items with the highest unit cost will be used. (All other items used will be paid per associated line items.)

The anticipated costs for all bonds, insurance, permits, delivery charges, freight, fuel and any other preconstruction expenses necessary to adequately carry out said work shall be included in this cost per each project.

Barricades

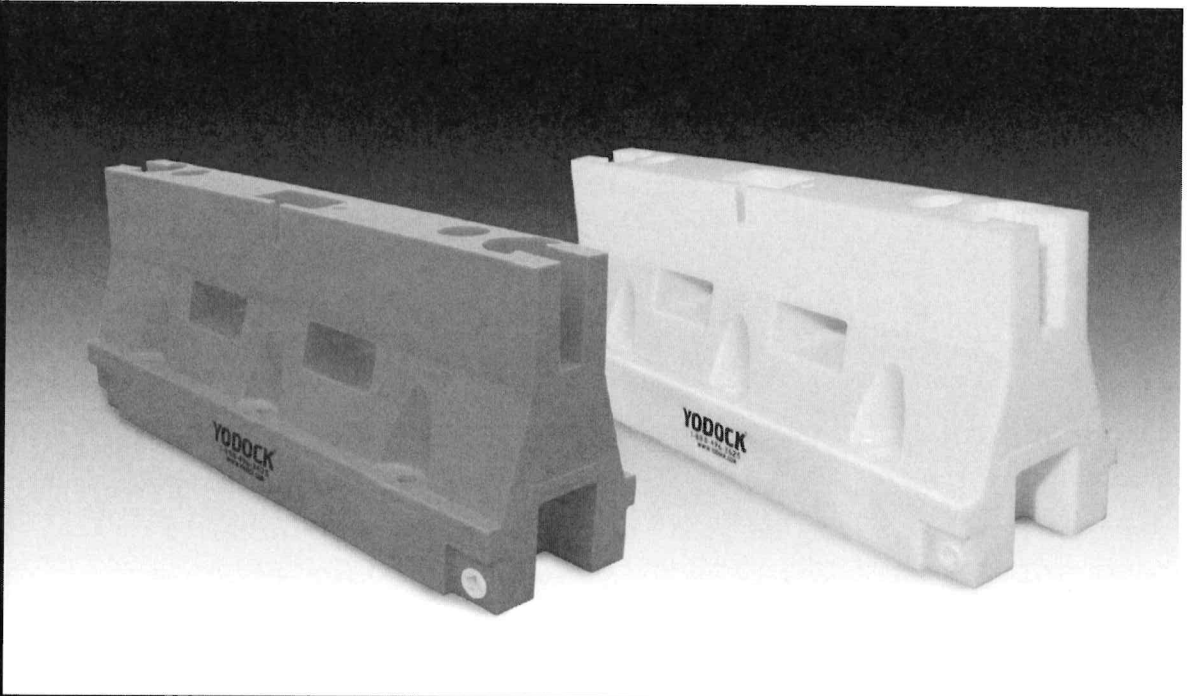

Yodock® 2001M

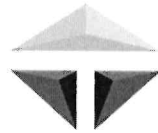

TRINITY
HIGHWAY
RENTALS

Yodock® 2001M

The Yodock® 2001M Barricade is a plastic, water-filled Longitudinal Channelizing Device (LCD) used for traffic and pedestrian channelization, road and street closures, or perimeter fencing for vertical construction. When assembled as an LCD, the units are attached end-to-end using a plastic coupler and may be deployed either empty or full.

Additional accessories are available that allow the Yodock® 2001M barricade to be used for temporary sign supports, perimeter fencing, and certain TL-2 longitudinal barrier applications.

Applications

- Construction & Temporary Work Zones
- Longitudinal Channelizer
- Temporary Sign Support
- Perimeter Fencing
- Airport Construction & Maintenance
- Parking Facilities
- Municipal & Public Utilities
- Security Checkpoints
- Events & Crowd Control
- Parks & Recreational Facilities

Features

- Lightweight system enables convenient positioning by hand.
- Can be accessorized for longitudinal barrier, perimeter fencing, road closure, and temporary sign support applications.
- Stackable for more efficient transportation and storage.
- Made of Low Density Polyethylene (LDPE).
- Convenient forklift access for maneuverability.
- Available in custom colors.

FHWA Eligibility

- Longitudinal Channelizing Device (LCD)
- Work Zone Barricade
- Temporary Sign Support
- Longitudinal Barrier
(When used with Steel Rail Kit)

Specifications

- 6' Length
- 18" Width
- 32" Height
- Empty Weight: 75 lbs.
- Full Weight: 750 lbs.

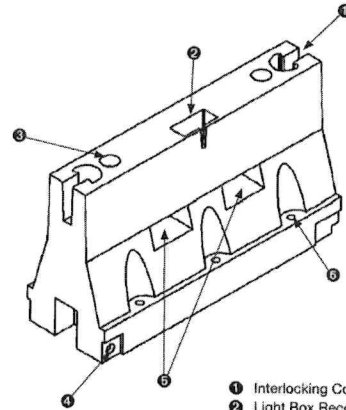

- 1 Interlocking Coupler
- 2 Light Box Recess
- 3 Fill Hole
- 4 Drain Hole
- 5 Forklift Access
- 6 Ground Mounting Ports

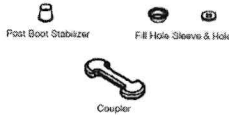

An original **YODOCK** product.

Distributed by:



**TRINITY
HIGHWAY
RENTALS**

Copyright © 2019 Trinity Highway Products, LLC. All Rights Reserved.

4-19

TrinityHighwayRentals.com

1.888.496.3625

Crash Cushions

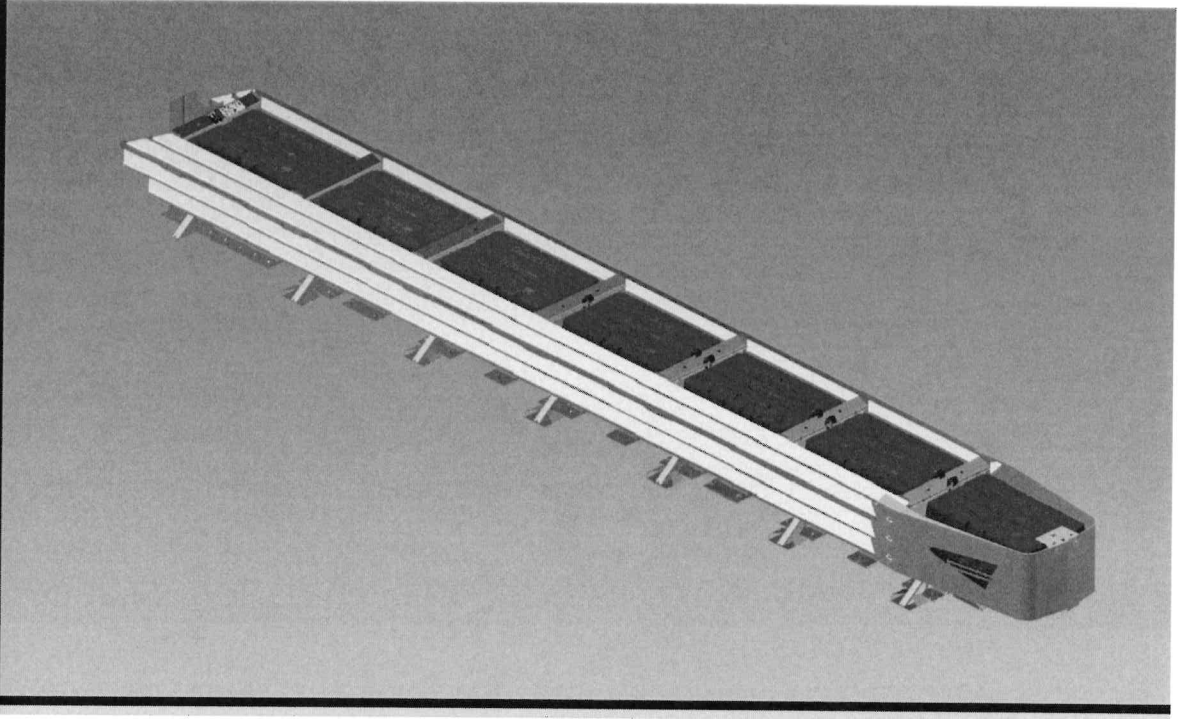

QuadGuard® M10

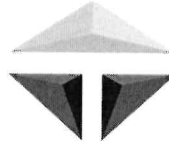
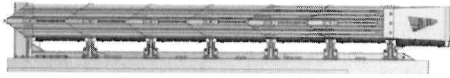

TRINITY
HIGHWAY
Ahead of the Curve®

QuadGuard® M10

The QuadGuard® M10 is a redirective, non-gating crash cushion that consists of an engineered steel nose and crushable, energy absorbing cartridges surrounded by a framework of steel Quad-Beam™ panels. The system is tested to the Manual for Assessing Safety Hardware (MASH) Test Level 3 and Test Level 2. It can be used to shield fixed objects up to 24" (610 mm). A wide Test Level 3 system, the QuadGuard M Wide, is also available for fixed objects up to 69" (1.75 m).

The QuadGuard® M10, as a member of the QuadGuard® family of crash cushions, consists of many of the same components as the original Test Level 3 QuadGuard® platform and framework in addition to an engineered steel nose and monorail shims.

Features

- Self-supporting steel nose.
- Tension strut backup.
- Monorail guide stabilizers.
- Anchorage in concrete.
- High strength Quad-Beam™ panels.
- Does not use anchoring chains or tension cables.

Assembly and Maintenance

- Damaged cartridges are replaceable.
- Potentially reusable after an impact within MASH crash test standards.*

Specifications

QuadGuard M10 Test Level 3 System

- System Length – 22' 0" (6.71 m)
- System Width – 24" (610 mm)

QuadGuard M Wide Test Level 3 System (not shown)

- System Length – 22' 0" (6.71 m)
- System Width – 69" (1.75 m)

QuadGuard M10 Test Level 2 System

- System Length – 13' 0" (3.96 m)
- System Width – 24" (610 mm)

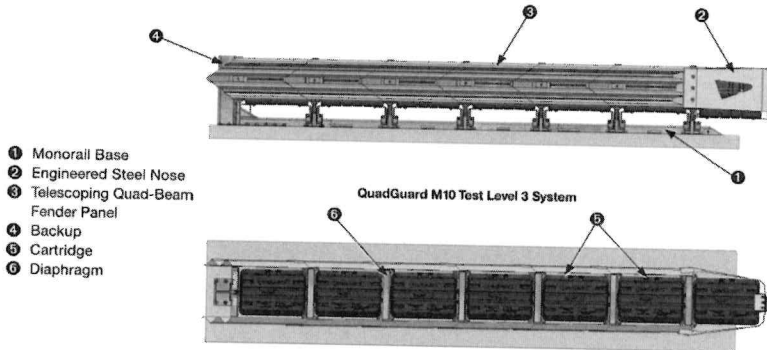

An original  product.

Distributed by:



4-20
www.trinityhighway.com
 1.888.323.6374

 **TRINITY
HIGHWAY**

Copyright © 2020 Trinity Highway Products, LLC. All Rights Reserved.

*After an impact, the product must be inspected and evaluated per the direction of the specifying roadway authority. The ultimate decision on reusability rests with the specifying roadway authority and/or state DOT.