



**LOUISIANA STATE UNIVERSITY  
HEALTH SCIENCES CENTER  
HUMAN DEVELOPMENT CENTER STUDY ROOMS  
VERSTEEL BRAND FURNITURE  
PURCHASE CONTRACT**

## **Special Conditions Bid #002795**

**Deadline for bid submission will be Tuesday, June 4, 2024 @ 2:00PM**

### **SECTION 1 – BIDDING AND CONTRACT DOCUMENTS**

#### **1.1 Definitions:**

**Bidder** – a legal entity that submits an offer to sell to the Owner on a specified body of work. Generally where the term “Bidder” is used in the specifications, the indication is that the requirement or responsibility is associated with the bid submittal or other pre-award activities.

**Supplier** – vendor that performs the services as specified herein. The term “Supplier” can also be used in the specification as an inclusive term that references the Supplier and all persons, or other parties of interest acting on behalf of the Supplier in the performance of the contract as described in the specifications.

#### **1.2 Interpretation of Documents and Prior Approvals:**

If any person contemplating submitting a bid is in doubt of the meaning of any part of the specifications or other proposed contract documents, they may submit to Michael Williams e-mail at [MWIL34@LSUHSC.EDU](mailto:MWIL34@LSUHSC.EDU) or fax to 504-717-2901 a written request for an interpretation not later than NOON on Thursday, May 23, 2024. Any interpretation of documents will be made only by addendum duly issued and mailed or delivered to each bidder receiving a set of the specifications. LSUHSC will not be responsible for any other explanations or interpretation of the specifications or proposed documents.

#### **1.3 Pre-Bid Conference:**

There will be no Pre-Bid Conference for this solicitation.

#### **1.4 Bidder's Representation:**

Each Bidder by his bid represents the following:

- Bidder has read and understands the Bidding Documents and his or her bid is made in accordance therewith.
- Bidder's bid is based solely upon the materials, systems and services described in the Bidding Documents as advertised and as modified by addenda.
- Bid is not based on any verbal instructions contrary to the Contract Documents and addenda

## **1.5 Bidding Procedure & Bid Submission:**

Bidders must properly complete and sign Bid, including all required attestations and addenda. Any exceptions to the attached terms and conditions or the indemnification agreement shall be presented at the time of the bid submission. Note that any exceptions may result in a disqualified bid if the aforementioned exceptions are in conflict with state guidelines governing LSUHSC. Bids must be signed by a representative of your company authorized to enter into contracts on behalf of your organization in accordance with Louisiana R.S. 39:1594.

### **These documents must be included with the bid:**

1. INVITATION TO BID
2. SPECIFICATIONS PRICE SHEET
3. ATTACHMENT A - CERTIFICATION STATEMENT
4. ATTACHMENT B - INDEMNIFICATION AGREEMENT
5. ATTACHMENT C - EQUAL EMPLOYMENT OPPORTUNITY CLAUSE
6. ATTACHMENT D – AFFIRMATIVE ACTION COMPLIANCE
7. CERTIFICATE OF LIABILITY INSURANCE
8. ADDENDA REQUIRING A SIGNATURE

All bids are due by 2:00 PM, Tuesday, June 4, 2024, at 433 Bolivar Street, Room 623 (Purchasing Department), New Orleans, LA 70112. **Late bids will not be accepted, and will be returned unopened.** It is the bidder's responsibility to make sure bids are delivered before the bid opening. Fax or e-mail bids will not be accepted. Delays by mail, traffic, or any other reason will be at the bidders own risk. The bid package must be delivered at the Bidder's expense to:

Michael Williams – Senior Buyer  
Louisiana State University Health Sciences Center – New Orleans  
433 Bolivar Street  
Room 623  
New Orleans, LA 70112  
Phone: (504) 568-6261  
Fax: (504) 717-2901

### **BIDS SHALL BE DELIVERED IN A SEALED ENVELOPE WITH THE BID NUMBER CLEARLY MARKED ON THE OUTSIDE OF THE ENVELOPE.**

In accordance with R.S. 39:1581, Chapter 5, Section 521C of the Louisiana State Purchasing Rules and Regulations, when an error is made in extending total prices, the unit bid price will govern.

Award: LSUHSC-NO will award to the lowest responsive and responsible bidder based on the unit pricing of any and all items.

**1.6 Minimum Insurance Requirements:**

Selected bidder(s) shall maintain the following minimum insurance coverage throughout the duration of the contract:

- Commercial General Liability: \$1,000,000 combined single limit per occurrence for bodily injury, personal injury and property damage.
- Automobile Liability: \$1,000,000 combined single limit per accident, for bodily injury and property damage.
- Workers Compensation and Employers Liability: Workers' Compensation limits as required by the Labor Code of the State of Louisiana and Employers Liability coverage. Exception: Employers liability limit is to be \$1,000,000 when work is to be over water and involves maritime exposure.

A Certificate of Liability Insurance must be provided with bid. For further insurance requirements and provisions, see Attachment E – Insurance Requirements.

**1.7 Calendar of Events:**

<b><u>Event</u></b>	<b><u>Date</u></b>
ITB Announcement	May 14, 2024
Written Inquiry Deadline (12:00 Noon)	May 23, 2024
Issue Responses to Provider Inquiries	May 24, 2024
Bid Submission Deadline (2:00 PM)	June 4, 2024
Bid Award & Notification	June 5, 2024

NOTE: LSUHSC reserves the right to amend and/or change this schedule of ITB activities, as it deems necessary.

**1.8 Compliance with Applicable Laws and Regulations:**

Supplier shall perform all requirements under this contract in strict observance of and in compliance with all applicable laws, regulations, ordinances, codes and any other legislative or statutory requirements. Supplier warrants the performance of services under this contract shall be fully compliant with the current requirements of the Occupational Safety and Health Act (OSHA) to include as it may be amended throughout the term of this contract. Supplier shall take precautions to insure work is performed in compliance with occupational safety standards. Supplier shall obtain all permits and licenses and pay all taxes, charges and fees necessary to perform the services under this contract.

**1.9 Resolving Contract Disputes:**

State statute requires that disputes arising under this contract not be resolved in a forum outside of Louisiana. Requiring contract disputes to be resolved in a forum outside of this state or requiring their interpretation to be governed by the laws of another jurisdiction, are inequitable and against the public policy of this state.

**1.10 Late Payment Policy:**

State statute RS 39:1695 requires that if a state agency fails to make any payment within 90 days of the due date, that agency shall pay, in addition to the payment, interest on the amount due at the rate established pursuant to Civil Code Article 2824 (B) (3) per year, from the 91<sup>st</sup> day after the due date.

## **SECTION 2 – SCOPE (GENERAL)**

### **2.1 Summary:**

The LSU Health Sciences Center in New Orleans (LSUHSC) requests bids for Versteel Furniture as specified in the Specifications Price Sheet. This is an All or None bid. This bid is brand specific based on LSUHSC standards. Substitutions are not allowed. Price quotes are to include freight (FOB Destination), inside delivery, assembly, set in place, and removal of packing materials and trash, to the LSUHSC Human Development Center, 411 S. Prieur St., New Orleans, LA, 70112. Preferred delivery 6 weeks after receipt of purchase order.

### **2.2 LSUHSC Representation:**

The intended designated representative of LSUHSC for this service is Rachelle Falcon, Facilities. Any changes to the scope of work or scheduling must be submitted to the designated LSUHSC representative. Rachelle Falcon can be contacted via phone at 504-568-2834.

### **2.3 Warranty and Guarantee:**

Supplier warrants and guarantees all equipment to be new. All items shall have a 100% warranty against defects in material and workmanship for a period of not less than three years which shall start when the equipment has been delivered, tested, and accepted. When a manufacturer's normal warranty period is greater than one year, or where a longer period is specified, such longer period shall apply. Any required visits by a service technician must be made within 48 hours of a call for service.

# Invitation to Bid

<b>LSUHSC New Orleans</b>		BIDS WILL BE PUBLICLY OPENED:  <b>June 04, 2024                      02:00 PM</b>
VENDOR NO. : SOLICITATION : <b>002795</b> OPENING DATE : <b>06/04/2024</b>		Return Sealed Bid to: Purchasing Department 433 Bolivar St Room 623 New Orleans LA 70112  BUYER : Williams, Michael D. BUYER PHONE : 504/568-6261 DATE ISSUED : 05/14/2024 REQ. NO : FISCAL YEAR : 0
<b>Versteel Furniture for HDC</b>		
To be Completed by Vendor:		
BUSINESS NAME _____ ADDRESS _____ TAX ID NUMBER _____		
_____ % CASH DISCOUNT FOR PROMPT PAYMENT IF MADE WITHIN THIRTY 30 DAYS. CASH DISCOUNTS FOR LESS THAN 30 DAYS OR LESS THAN 1% WILL BE ACCEPTED, BUT WILL NOT BE CONSIDERED IN DETERMINING AWARDS. ON INDEFINITE QUANTITY TERM CONTRACTS, CASH DISCOUNTS WILL BE ACCEPTED AND TAKEN BUT WILL NOT BE CONSIDERED IN DETERMINING AWARDS.		
<b>INSTRUCTION TO BIDDERS</b>		
1. READ THE ENTIRE BID (INCLUDING ALL TERMS AND CONDITIONS AND SPECIFICATIONS). DIVERSE SUPPLIER (A) SUPPLIER UNDERSTANDS THAT LSU, AS THE STATE'S FLAGSHIP UNIVERSITY, HAS AN INTEREST IN PROVIDING ENTREPRENEURIAL OPPORTUNITIES TO DIVERSITY-OWNED BUSINESSES. THE UNIVERSITY IS DEDICATED TO PROMOTING THE GROWTH AND DEVELOPMENT OF MINORITY, WOMEN, AND SMALL AND HISTORICALLY UNDERUTILIZED BUSINESSES ("DIVERSE BUSINESSES") BY PROVIDING OPPORTUNITIES TO PARTICIPATE IN UNIVERSITY CONTRACTS. (B) IN SUPPORT OF THIS COMMITMENT, THE SUPPLIER SHALL USE GOOD FAITH AND BEST EFFORTS TO PROVIDE OPPORTUNITIES TO DIVERSE BUSINESSES THAT ARE EITHER CERTIFIED BY THE STATE OR ANOTHER CERTIFYING AGENCY IN A DIVERSE CATEGORY, AS A SUBCONTRACTOR OR SUPPLIER UNDER THIS AGREEMENT. (C) IF APPLICABLE, SUPPLIER SHALL PROVIDE LSU WITH A LIST OF DIVERSITY-OWNED BUSINESSES DURING EACH CONTRACT YEAR, THE LIST OF BUSINESSES SHOULD IDENTIFY: (1) THE NAME OF THE BUSINESS; (2) ITS PRINCIPAL OFFICE OR ADDRESS; (3) THE OWNER(S); AND (4) THE SERVICES OR GOODS THAT IT MAY PROVIDE OR SUPPLY AND THE VALUE OF THE GOODS OR SERVICES PROCURED FROM THE BUSINESSES INCLUDED ON SUPPLIER'S LIST. (D) TO THE EXTENT THAT ANY FEDERAL OR STATE LAW, RULE, OR REGULATION WOULD REQUIRE THAT THIS SECTION BE MODIFIED OR VOIDED, THE PARTIES AGREE THAT SUCH PROVISION CAN BE AMENDED OR SEVERED FROM THE AGREEMENT WITHOUT AFFECTING ANY OF THE OTHER TERMS OF THE AGREEMENT.		
2. ALL BID PRICES MUST BE TYPED OR WRITTEN IN INK. ANY CORRECTIONS, ERASURES OR OTHER FORMS OF ALTERATION TO UNIT PRICES SHOULD BE INITIALIZED BY THE BIDDER.		
3. THIS BID IS TO BE MANUALLY SIGNED IN INK BY A PERSON AUTHORIZED TO BIND THE VENDOR (See No.9).		
VENDOR PHONE NUMBER:	TITLE	DATE
EMAIL ADDRESS:		
SIGNATURE OF AUTHORIZED BIDDER (MUST BE SIGNED) .	NAME OF BIDDER (TYPED OR PRINTED)	

# Invitation to Bid

STANDARD TERMS & CONDITIONS

Page 2 of 10

NUMBER : 002795  
OPEN DATE : 06/04/2024 TIME: 02:00 PM

BIDDER:

4. BID PRICES SHALL INCLUDE DELIVERY OF ALL ITEMS F.O.B. DESTINATION OR AS OTHERWISE PROVIDED. BIDS CONTAINING "PAYMENT IN ADVANCE" OR "C.O.D." REQUIREMENTS MAY BE REJECTED. PAYMENT IS TO BE MADE WITHIN 30 DAYS AFTER RECEIPT OF A PROPERLY EXECUTED INVOICE THAT IS APPROVED BY LSUHSC OR DELIVERY, WHICHEVER IS LATER.

5. DESIRED DELIVERY: 10 DAYS AFTER RECEIPT OF ORDER, UNLESS SPECIFIED ELSEWHERE.

6. TO ASSURE CONSIDERATION OF YOUR BID, SEE HEADER FOR RETURN INSTRUCTIONS. ALL BIDS AND ADDENDA SHOULD BE RETURNED IN AN ENVELOPE OR PACKAGE AND CLEARLY ENDORSED WITH THE BID OPENING DATE, BID OPENING TIME, BID NUMBER, AND BID TITLE. ALL REQUEST FOR QUOTATIONS AND ADDENDA SHOULD BE SUBMITTED VIA FAX, EMAIL OR PLACED IN AN ENVELOPE AND DELIVERED.

7. BIDS SUBMITTED ARE SUBJECT TO PROVISIONS OF THE LAWS OF THE STATE OF LOUISIANA INCLUDING BUT NOT LIMITED TO L.R.S. 39:1551-1736; PURCHASING RULES AND REGULATIONS; EXECUTIVE ORDERS; STANDARD TERMS AND CONDITIONS; SPECIAL CONDITIONS; AND SPECIFICATIONS LISTED IN THIS SOLICITATION.

**PROHIBITION OF DISCRIMINATORY BOYCOTTS OF ISRAEL:**

IN ACCORDANCE WITH EXECUTIVE ORDER NUMBER JBE 2018-15, EFFECTIVE MAY 22, 2018, FOR ANY CONTRACT FOR \$100,000 OR MORE AND FOR ANY CONTRACTOR WITH FIVE OR MORE EMPLOYEES, CONTRACTOR, OR ANY SUBCONTRACTOR, SHALL CERTIFY IT IS NOT ENGAGING IN A BOYCOTT OF ISRAEL, AND SHALL, FOR THE DURATION OF THIS CONTRACT, REFRAIN FROM A BOYCOTT OF ISRAEL. THE STATE RESERVES THE RIGHT TO TERMINATE THIS CONTRACT IF THE CONTRACTOR, OR ANY SUBCONTRACTOR, ENGAGES IN A BOYCOTT OF ISRAEL DURING THE TERM OF THE CONTRACT.

**8. IMPORTANT:**

BY SIGNING THIS BID, THE BIDDER CERTIFIES COMPLIANCE WITH ALL INSTRUCTIONS TO BIDDERS, TERMS, CONDITIONS, AND SPECIFICATIONS AND FURTHER CERTIFIES THAT THIS BID IS MADE WITHOUT COLLUSION OR FRAUD. ALL BID INFORMATION SHALL BE MADE WITH INK OR TYPEWRITTEN.

**9. SIGNATURE AUTHORITY:**

SUBMIT EVIDENCE WITH THE BID OR UPON REQUEST

R.S. 39:1594 (C) (4) EVIDENCE OF AGENCY, CORPORATE, OR PARTNERSHIP AUTHORITY SHALL BE REQUIRED FOR SUBMISSION OF A BID TO PURCHASING AGENCIES OF THE STATE OF LOUISIANA.

THE AUTHORITY OF THE SIGNATURE OF THE PERSON SUBMITTING THE BID SHALL BE DEEMED SUFFICIENT AND ACCEPTABLE IF ANY OF THE FOLLOWING CONDITIONS ARE MET:

- (A) THE SIGNATURE ON THE BID IS THAT OF ANY CORPORATE OFFICER LISTED ON THE MOST CURRENT ANNUAL REPORT ON FILE WITH THE SECRETARY OF STATE, OR THE SIGNATURE ON THE BID IS THAT OF ANY MEMBER OF A PARTNERSHIP OR PARTNERSHIP IN COMMENDAM LISTED IN THE MOST CURRENT PARTNERSHIP RECORDS ON FILE WITH THE SECRETARY OF STATE.
- (B) THE SIGNATURE ON THE BID IS THAT OF AN AUTHORIZED REPRESENTATIVE OF THE CORPORATION, PARTNERSHIP, OR OTHER LEGAL ENTITY AND THE BIDDER SUBMITS OR PROVIDES UPON REQUEST A CORPORATE RESOLUTION, CERTIFICATION AS TO THE CORPORATE PRINCIPAL, OR OTHER DOCUMENTS INDICATING AUTHORITY WHICH ARE ACCEPTABLE TO THE PUBLIC ENTITY, INCLUDING REGISTRATION ON AN ELECTRONIC INTERNET DATABASE MAINTAINED BY THE PUBLIC ENTITY.
- (C) THE CORPORATION, PARTNERSHIP, OR OTHER LEGAL ENTITY HAS FILED IN THE APPROPRIATE RECORDS OF THE SECRETARY OF STATE IN WHICH THE PUBLIC ENTITY IS LOCATED, AN AFFIDAVIT, RESOLUTION, OR OTHER ACKNOWLEDGED OR

# Invitation to Bid

STANDARD TERMS & CONDITIONS

Page 3 of 10

NUMBER : 002795  
OPEN DATE : 06/04/2024 TIME: 02:00 PM

BIDDER:

AUTHENTIC DOCUMENT INDICATING THE NAMES OF ALL PARTIES AUTHORIZED TO SUBMIT BIDS FOR PUBLIC CONTRACTS. SUCH DOCUMENT ON FILE WITH THE SECRETARY OF STATE SHALL REMAIN IN EFFECT AND SHALL BE BINDING UPON THE PRINCIPAL UNTIL SPECIFICALLY RESCINDED AND CANCELED FROM THE RECORDS OF THE RESPECTIVE OFFICES.

IT IS ACCEPTABLE FOR THE SIGNATURE ON THE BID TO BE LISTED AS A VENDOR CONTACT ON LAPAC (LOUISIANA PROCUREMENT AND CONTRACT NETWORK)

10. INQUIRIES:

ADDRESS ALL INQUIRIES AND CORRESPONDENCE TO THE BUYER AT THE PHONE NUMBER AND ADDRESS SHOWN ABOVE.

11. BID FORMS:

ALL WRITTEN BIDS, UNLESS OTHERWISE PROVIDED FOR, MUST BE SUBMITTED ON, AND IN ACCORDANCE WITH FORMS PROVIDED AND PROPERLY SIGNED. BIDS SUBMITTED IN THE FOLLOWING MANNER WILL NOT BE ACCEPTED:

- A. BID CONTAINS NO SIGNATURE INDICATING INTENT TO BE BOUND
- B. BID FILLED OUT IN PENCIL; AND
- C. BID NOT SUBMITTED PER THE SOLICITATION DOCUMENT.

BIDS MUST BE RECEIVED AT THE ADDRESS SPECIFIED IN THE SOLICITATION PRIOR TO BID OPENING TIME IN ORDER TO BE CONSIDERED.

12. STANDARDS OR QUALITY:

ANY PRODUCT OR SERVICE BID SHALL CONFORM TO ALL APPLICABLE FEDERAL AND STATE LAWS AND REGULATIONS AND THE SPECIFICATIONS CONTAINED IN THE SOLICITATION. UNLESS OTHERWISE SPECIFIED IN THE SOLICITATION, ANY MANUFACTURER'S NAME, TRADE NAME, BRAND NAME, OR CATALOG NUMBER USED IN THE SPECIFICATION IS FOR THE PURPOSE OF DESCRIBING THE STANDARD OF QUALITY, PERFORMANCE, AND CHARACTERISTICS DESIRED AND IS NOT INTENDED TO LIMIT OR RESTRICT COMPETITION. BIDDER MUST SPECIFY THE BRAND AND MODEL NUMBER OF THE PRODUCT OFFERED IN HIS/HER BID. BIDS NOT SPECIFYING BRAND AND MODEL NUMBER SHALL BE CONSIDERED AS OFFERING THE EXACT PRODUCTS SPECIFIED IN THE SOLICITATION. LSUHSC RESERVES THE RIGHT TO INSPECT AND TEST THE DELIVERED ITEMS FOR COMPLIANCE WITH THE BID SPECIFICATIONS. IF THE ITEM FAILS TO MEET THE SPECIFICATIONS, THE COST OF TEST AND INSPECTION WILL BE PAID BY THE CONTRACTOR. IF THE ITEM IS IN COMPLIANCE, COST OF ALL TESTS WILL BE PAID BY LSUHSC.

13. DESCRIPTIVE INFORMATION:

BIDDERS PROPOSING AN EQUIVALENT BRAND OR MODEL SHOULD SUBMIT WITH THE BID, INFORMATION (SUCH AS ILLUSTRATIONS, DESCRIPTIVE LITERATURE, AND TECHNICAL DATA) SUFFICIENT FOR LSUHSC TO EVALUATE QUALITY, SUITABILITY, AND COMPLIANCE WITH THE SPECIFICATIONS IN THE SOLICITATION. FAILURE TO SUBMIT DESCRIPTIVE INFORMATION MAY CAUSE BID TO BE REJECTED. ANY CHANGE MADE TO A MANUFACTURER'S PUBLISHED SPECIFICATION SUBMITTED FOR A PRODUCT SHALL BE VERIFIABLE BY THE MANUFACTURER. IF ITEM(S) BID DO NOT FULLY COMPLY WITH SPECIFICATIONS (INCLUDING BRAND AND/OR PRODUCT NUMBER), BIDDER MUST STATE IN WHAT RESPECT ITEMS(S) DEVIATE. FAILURE TO NOTE EXCEPTIONS ON THE BID FORM WILL NOT RELIEVE THE SUCCESSFUL BIDDER(S) FROM SUPPLYING THE ACTUAL PRODUCTS REQUESTED.

14. BID OPENING:

BIDDERS MAY ATTEND THE BID OPENING, BUT NO INFORMATION OR OPINIONS CONCERNING THE ULTIMATE CONTRACT AWARD WILL BE GIVEN AT THE BID OPENING OR DURING THE EVALUATION PROCESS. BIDS MAY BE EXAMINED WITHIN 72 HOURS AFTER BID OPENING. INFORMATION PERTAINING TO COMPLETED FILES MAY BE SECURED BY VISITING LSUHSC DURING NORMAL



# Invitation to Bid

STANDARD TERMS & CONDITIONS

Page 4 of 10

NUMBER : 002795  
OPEN DATE : 06/04/2024 TIME: 02:00 PM

BIDDER:

WORKING HOURS. WRITTEN BID TABULATIONS WILL NOT BE FURNISHED.

15. AWARDS:

AWARD WILL BE MADE TO THE LOWEST RESPONSIBLE AND RESPONSIVE BIDDER. LSUHSC RESERVES THE RIGHT TO AWARD ITEMS SEPARATELY, GROUPED, OR ON AN ALL OR NONE BASIS, AND TO REJECT ANY OR ALL BIDS AND WAIVE ANY INFORMALITIES.

16. PRICES:

UNLESS OTHERWISE SPECIFIED BY LSUHSC IN THE SOLICITATION, BID PRICES MUST BE COMPLETE, INCLUDING TRANSPORTATION PREPAID BY BIDDER TO DESTINATION AND FIRM FOR ACCEPTANCE FOR A MINIMUM OF 30 DAYS. IF ACCEPTED, PRICES MUST BE FIRM FOR THE CONTRACTUAL PERIOD. BIDS OTHER THAN F.O.B. DESTINATION MAY BE REJECTED. PRICES SHOULD BE QUOTED IN THE UNIT (EACH, BOX, CASE, ETC.) AS SPECIFIED IN THE SOLICITATION.

17. TAXES:

VENDOR IS RESPONSIBLE FOR INCLUDING ALL APPLICABLE TAXES IN THE BID PRICE. LSUHSC AGENCIES ARE EXEMPT FROM ALL STATE AND LOCAL SALES AND USE TAXES.

18. NEW PRODUCTS:

UNLESS SPECIFICALLY CALLED FOR IN THE SOLICITATION, ALL PRODUCTS FOR PURCHASE MUST BE NEW, NEVER PREVIOUSLY USED, AND THE CURRENT MODEL AND/OR PACKAGING. NO REMANUFACTURED, DEMONSTRATOR, USED OR IRREGULAR PRODUCT WILL BE CONSIDERED FOR PURCHASE UNLESS OTHERWISE SPECIFIED IN THE SOLICITATION. THE MANUFACTURER'S STANDARD WARRANTY WILL APPLY UNLESS OTHERWISE SPECIFIED IN THE SOLICITATION.

19. CONTRACT RENEWALS:

UPON AGREEMENT OF LSUHSC AND THE CONTRACTOR, A TERM CONTRACT MAY BE EXTENDED FOR 4 (FOUR) ADDITIONAL 12 MONTH PERIODS AT THE SAME PRICES, TERMS AND CONDITIONS. IN SUCH CASES, THE TOTAL CONTRACT TERM CANNOT EXCEED 60 MONTHS. RS 39:1615

20. CONTRACT CANCELLATION:

TERMINATION FOR NONCOMPLIANCE:

LSUHSC HAS THE RIGHT TO CANCEL ANY CONTRACT, IN ACCORDANCE WITH PURCHASING RULES AND REGULATIONS, FOR CAUSE INCLUDING BUT NOT LIMITED TO THE FOLLOWING:

- (1) FAILURE TO DELIVER WITHIN THE TIME SPECIFIED IN THE CONTRACT;
- (2) FAILURE OF THE PRODUCT OR SERVICE TO MEET SPECIFICATIONS, CONFORM TO SAMPLE QUALITY OR TO BE DELIVERED IN GOOD CONDITION;
- (3) MISREPRESENTATION BY THE CONTRACTOR;
- (4) FRAUD, COLLUSION, CONSPIRACY OR OTHER UNLAWFUL MEANS OF OBTAINING ANY CONTRACT WITH THE STATE;
- (5) CONFLICT OF CONTRACT PROVISIONS WITH CONSTITUTIONAL OR STATUTORY PROVISIONS OF STATE OR FEDERAL LAW;
- (6) ANY OTHER BREACH OF CONTRACT.

FURTHER, LSUHSC MAY TERMINATE THIS CONTRACT FOR CAUSE BASED UPON THE FAILURE OF THE CONTRACTOR TO COMPLY WITH THE TERMS AND/OR CONDITIONS OF THE CONTRACT; PROVIDED THAT LSUHSC SHALL GIVE THE CONTRACTOR WRITTEN NOTICE SPECIFYING THE FAILURE. IF WITHIN THIRTY (30) DAYS AFTER RECEIPT OF SUCH NOTICE, THE CONTRACTOR SHALL NOT HAVE EITHER CORRECTED SUCH FAILURE OR, IN THE CASE WHICH CANNOT BE CORRECTED IN THIRTY (30) DAYS, BEGUN IN GOOD FAITH TO CORRECT SAID FAILURE AND THEREAFTER PROCEEDED DILIGENTLY TO COMPLETE SUCH CORRECTION, THEN LSUHSC MAY, AT ITS OPTION, PLACE THE CONTRACTOR IN DEFAULT AND THE CONTRACT SHALL TERMINATE ON THE DATE

# Invitation to Bid

STANDARD TERMS & CONDITIONS

Page 5 of 10

NUMBER : 002795  
OPEN DATE : 06/04/2024 TIME: 02:00 PM

BIDDER:

SPECIFIED IN SUCH NOTICE. THE CONTRACTOR MAY EXERCISE ANY RIGHTS AVAILABLE TO IT UNDER LOUISIANA LAW TO TERMINATE FOR CAUSE UPON THE FAILURE OF LSUHSC TO COMPLY WITH THE TERMS AND CONDITIONS OF THIS CONTRACT; PROVIDED THAT THE CONTRACTOR SHALL GIVE LSUHSC WRITTEN NOTICE SPECIFYING LSUHSC'S FAILURE AND A REASONABLE OPPORTUNITY FOR LSUHSC TO CURE THE DEFECT

**TERMINATION FOR CONVENIENCE:**

LSUHSC MAY, AT ANY TIME, TERMINATE THE CONTRACT FOR THEIR CONVENIENCE AND WITHOUT CAUSE. UPON RECEIPT OF WRITTEN NOTICE FROM LSUHSC OF SUCH TERMINATION FOR THEIR CONVENIENCE, THE CONTRACTOR SHALL: CEASE OPERATIONS AS DIRECTED BY LSUHSC IN THE NOTICE; TAKE ACTIONS NECESSARY, OR THAT LSUHSC MAY DIRECT, FOR THE PROTECTION AND PRESERVATION OF THE WORK; AND EXCEPT FOR WORK DIRECTED TO BE PERFORMED PRIOR TO THE EFFECTIVE DATE OF TERMINATION STATED IN THE NOTICE, TERMINATE ALL EXISTING SUBCONTRACTS AND PURCHASE ORDERS AND ENTER INTO NO FURTHER SUBCONTRACTS AND PURCHASE ORDERS. IN CASE OF SUCH TERMINATION FOR LSUHSC'S CONVENIENCE, THE CONTRACTOR SHALL BE ENTITLED TO RECEIVE PAYMENT FOR WORK EXECUTED. LSUHSC SHALL NOT BE RESPONSIBLE OR OTHERWISE LIABLE FOR ANY DEMOBILIZATION COSTS OR INCIDENTAL OR CONSEQUENTIAL DAMAGES RESULTING FROM SUCH TERMINATION.

**TERMINATION FOR NON-APPROPRIATION OF FUNDS:**

THE CONTINUATION OF THIS CONTRACT IS CONTINGENT UPON THE APPROPRIATION OF FUNDS TO FULFILL THE REQUIREMENTS OF THE CONTRACT.

**21. DEFAULT OF CONTRACT:**

FAILURE TO DELIVER WITHIN THE TIME SPECIFIED IN THE BID WILL CONSTITUTE A DEFAULT AND MAY CAUSE CANCELLATION OF THE CONTRACT. WHERE THE UNIVERSITY HAS DETERMINED THE CONTRACTOR TO BE IN DEFAULT, THE UNIVERSITY RESERVES THE RIGHT TO PURCHASE ANY OR ALL PRODUCTS OR SERVICES COVERED BY THE CONTRACT ON THE OPEN MARKET AND TO CHARGE THE CONTRACTOR WITH COST IN EXCESS OF THE CONTRACT PRICE. UNTIL SUCH ASSESSED CHARGES HAVE BEEN PAID, NO SUBSEQUENT BID FROM THE DEFAULTING CONTRACTOR WILL BE CONSIDERED.

**22. ORDER OF PRIORITY:**

IN THE EVENT THERE IS A CONFLICT BETWEEN THE INSTRUCTIONS TO BIDDERS OR STANDARD CONDITIONS AND THE SPECIAL CONDITIONS, THE SPECIAL CONDITIONS SHALL GOVERN.

**23. APPLICABLE LAW:**

ALL CONTRACTS SHALL BE CONSTRUED IN ACCORDANCE WITH AND GOVERNED BY THE LAWS OF THE STATE OF LOUISIANA.

**24. COMPLIANCE WITH CIVIL RIGHTS LAWS:**

BY SUBMITTING AND SIGNING THIS BID, BIDDER AGREES TO ABIDE BY THE REQUIREMENTS OF THE FOLLOWING AS APPLICABLE: TITLE VI AND VII OF THE CIVIL RIGHTS ACT OF 1964, AS AMENDED BY THE EQUAL OPPORTUNITY ACT OF 1972, FEDERAL EXECUTIVE ORDER 11246, FEDERAL REHABILITATION ACT OF 1973, AS AMENDED, THE VETERAN'S READJUSTMENT ASSISTANCE ACT OF 1974, TITLE IX OF THE EDUCATION AMENDMENTS OF 1972, THE AGE ACT OF 1975, AND BIDDER AGREES TO ABIDE BY THE REQUIREMENTS OF THE AMERICANS WITH DISABILITIES ACT OF 1990. BIDDER AGREES NOT TO DISCRIMINATE IN ITS EMPLOYMENT PRACTICES AND WILL RENDER SERVICES UNDER ANY CONTRACT ENTERED INTO AS A RESULT OF THIS SOLICITATION WITHOUT REGARD TO RACE, COLOR, RELIGION, SEX, AGE, NATIONAL ORIGIN, POLITICAL AFFILIATION, DISABILITY, VETERAN STATUS, OR ANY OTHER NON-MERIT FACTOR. ANY ACT OF DISCRIMINATION COMMITTED BY BIDDER, OR FAILURE TO COMPLY WITH THESE STATUTORY OBLIGATIONS WHEN APPLICABLE, SHALL BE GROUNDS FOR TERMINATION OF ANY CONTRACT ENTERED INTO AS A RESULT OF THIS SOLICITATION.

# Invitation to Bid

STANDARD TERMS & CONDITIONS

Page 6 of 10

NUMBER : 002795  
OPEN DATE : 06/04/2024 TIME: 02:00 PM

BIDDER:

25. SPECIAL ACCOMMODATIONS:

ANY "QUALIFIED INDIVIDUAL WITH A DISABILITY" AS DEFINED BY THE AMERICANS WITH DISABILITIES ACT WHO HAS SUBMITTED A BID AND DESIRES TO ATTEND THE BID OPENING, MUST NOTIFY THIS OFFICE IN WRITING NOT LATER THAN SEVEN DAYS PRIOR TO THE BID OPENING DATE OF THEIR NEED FOR SPECIAL ACCOMMODATIONS. IF THE REQUEST CANNOT BE REASONABLY PROVIDED, THE INDIVIDUAL WILL BE INFORMED PRIOR TO THE BID OPENING.

26. INDEMNITY:

CONTRACTOR AGREES, UPON RECEIPT OF WRITTEN NOTICE OF A CLAIM OR ACTION, TO DEFEND THE CLAIM OR ACTION, OR TAKE OTHER APPROPRIATE MEASURE, TO INDEMNIFY, AND HOLD HARMLESS, LSUHSC, ITS OFFICERS, ITS AGENTS AND ITS EMPLOYEES FROM AND AGAINST ALL CLAIMS AND ACTIONS FOR BODILY INJURY, DEATH OR PROPERTY DAMAGES CAUSED BY THE FAULT OF THE CONTRACTOR, OFFICERS, ITS AGENTS, OR ITS EMPLOYEES. CONTRACTOR IS OBLIGATED TO INDEMNIFY ONLY TO THE EXTENT OF THE FAULT OF THE CONTRACTOR, ITS OFFICERS, ITS AGENTS, OR ITS EMPLOYEES. HOWEVER, THE CONTRACTOR SHALL HAVE NO OBLIGATION AS SET FORTH ABOVE WITH RESPECT TO ANY CLAIM OR ACTION FROM BODILY INJURY, DEATH OR PROPERTY DAMAGES ARISING OUT OF THE FAULT OF THE UNIVERSITY, ITS OFFICERS, ITS AGENTS OR ITS EMPLOYEES.

27. IN ACCORDANCE WITH THE PROVISIONS OF (RS 39:2192):

IN AWARDING CONTRACTS, ANY PUBLIC ENTITY IS AUTHORIZED TO REJECT THE LOWEST BID FROM, OR NOT AWARD THE CONTRACT TO, A BUSINESS IN WHICH ANY INDIVIDUAL WITH AN OWNERSHIP INTEREST OF FIVE PERCENT OR MORE HAS BEEN CONVICTED OF, OR HAS ENTERED A PLEA OF GUILTY OR NOLO CONTENDERE TO ANY STATE FELONY CRIME OR EQUIVALENT FEDERAL FELONY CRIME COMMITTED IN THE SOLICITATION OR EXECUTION OF A CONTRACT OR BID AWARDED UNDER THE LAWS GOVERNING PUBLIC CONTRACTS UNDER THE PROVISIONS OF CHAPTER 10 OF TITLE 38 OF THE LOUISIANA REVISED STATUTES OF 1950, PROFESSIONAL, PERSONAL, CONSULTING, AND SOCIAL SERVICES PROCUREMENT UNDER THE PROVISIONS OF CHAPTER 16 OF TITLE 39, OR THE LOUISIANA PROCUREMENT CODE UNDER THE PROVISIONS OF CHAPTER 17 OF TITLE 39.

28. CERTIFICATION OF NO SUSPENSION OR DEBARMENT:

BY SIGNING AND SUBMITTING THIS BID, THE BIDDER CERTIFIES THAT THEIR BUSINESS ENTITY, ANY SUBCONTRACTORS OR PRINCIPALS ARE NOT SUSPENDED OR DEBARRED BY EITHER THE DEPARTMENT OF HEALTH AND HUMAN SERVICES, OFFICE OF INSPECTOR GENERAL (OIG) OR THE GENERAL SERVICES ADMINISTRATION (GSA) IN ACCORDANCE WITH THE REQUIREMENTS IN "AUDIT REQUIREMENTS IN SUBPART F OF THE OFFICE OF MANAGEMENT AND BUDGET'S UNIFORM ADMINISTRATIVE REQUIREMENTS, COST PRINCIPLES AND AUDIT REQUIREMENTS FOR FEDERAL AWARDS."

A LIST OF PARTIES WHO HAVE BEEN SUSPENDED OR DEBARRED CAN BE VIEWED VIA THE INTERNET AT [HTTPS://SAM.GOV](https://sam.gov)

IF AT ANY TIME DURING THE TERM OF THE CONTRACT AWARDED AS A RESULT OF THIS INVITATION TO BID, THIS ENTITY OR ANY OF ITS EMPLOYEES OR SUBCONTRACTORS APPEARS ON EITHER LISTING, THIS ENTITY WILL NOTIFY THE CONTRACTING AGENCY, AND THE CONTRACT WILL BE TERMINATED. THE CONTRACTING AGENCY WILL NOT BE LIABLE FOR ANY DAMAGES RESULTING FROM SAID TERMINATION.

29. FEDERAL CLAUSES (IF APPLICABLE):

ANTI-KICKBACK CLAUSE. THE CONTRACTOR HEREBY AGREES TO ADHERE TO THE MANDATE DICTATED BY THE COPELAND "ANTI-KICKBACK" ACT WHICH PROVIDES THAT EACH CONTRACTOR OR SUB GUARANTEE SHALL BE PROHIBITED FROM INDUCING BY ANY MEANS, ANY PERSON EMPLOYED IN THE COMPLETION OF WORK, TO GIVE UP ANY PART OF THE COMPENSATION TO WHICH HE IS OTHERWISE ENTITLED.

# Invitation to Bid

STANDARD TERMS & CONDITIONS

Page 7 of 10

NUMBER : 002795  
OPEN DATE : 06/04/2024 TIME: 02:00 PM

BIDDER:

**CLEAN AIR ACT:**

THE CONTRACTOR HEREBY AGREES TO ADHERE TO THE PROVISIONS WHICH REQUIRE COMPLIANCE WITH ALL APPLICABLE STANDARDS, ORDERS OR REQUIREMENTS ISSUED UNDER SECTION 306 OF THE CLEAN WATER ACT, WHICH PROHIBITS THE USE UNDER NON-EXEMPT FEDERAL CONTRACTS, GRANTS, OR LOANS OF FACILITIES INCLUDED ON THE EPA LIST OF VIOLATING FACILITIES.

**ENERGY POLICY AND CONSERVATION ACT:**

THE CONTRACTOR HEREBY RECOGNIZES THE MANDATORY STANDARDS AND POLICIES RELATING TO ENERGY EFFICIENCY WHICH ARE CONTAINED IN THE STATE ENERGY CONSERVATION PLAN ISSUED IN COMPLIANCE WITH THE ENERGY POLICY AND CONSERVATION ACT (P.L. 94-163)

**CLEAN WATER ACT:**

THE CONTRACTOR HERBY AGREES TO ADHERE TO THE PROVISIONS WHICH REQUIRE COMPLIANCE WITH ALL APPLICABLE STANDARDS, ORDERS, OR REQUIREMENTS ISSUED UNDER SECTION 508 OF THE CLEAN WATER ACT WHICH PROHIBITS THE USE UNDER NON-EXEMPT FEDERAL CONTRACTS, GRANTS, OR LOANS OF FACILITIES INCLUDED ON THE EPA LIST OF VIOLATING FACILITIES.

**ANTI-LOBBYING AND DEBARMENT ACT:**

THE CONTRACTOR WILL BE EXPECTED TO COMPLY WITH FEDERAL STATUTES REQUIRED IN THE ANTI-LOBBYING ACT AND THE DEBARMENT ACT.

**30. ADHERENCE TO JCAHO STANDARDS:**

WHERE APPLICABLE, LSUHSC IS ACCREDITED BY THE JOINT COMMISSION ON ACCREDITATION OF HEALTHCARE ORGANIZATIONS AND AS SUCH ALL CONTRACTORS, SUBCONTRACTORS, AND VENDORS AGREE TO ADHERE TO THE APPLICABLE STANDARDS PROMULGATED BY THE COMMISSION

**31. IN ACCORDANCE WITH LOUISIANA LAW, ALL CORPORATIONS (RS 12:163) AND LIMITED LIABILITY COMPANIES (RS 12:1308.2) MUST BE IN GOOD STANDING WITH THE LOUISIANA SECRETARY OF STATE IN ORDER TO HOLD A CONTRACT WITH THE STATE.**

**32. INTERPRETATION OF DOCUMENT:**

ANY INTERPRETATION OF THE BID OR QUOTATION DOCUMENT WILL ONLY BE MADE BY AN ADDENDUM ISSUED IN WRITING BY THE PURCHASING DEPARTMENT. SUCH ADDENDUM WILL BE MAILED OR DELIVERED TO EACH PERSON RECEIVING A SET OF THE ORIGINAL BID OR QUOTATION DOCUMENTS. LSUHSC WILL NOT BE RESPONSIBLE FOR ANY OTHER EXPLANATION OR INTERPRETATION OF THE DOCUMENTS.

**33. THIS SOLICITATION CONTAINS ALL TERMS AND CONDITIONS WITH RESPECT TO THE PURCHASE OF THE GOODS AND OR SERVICES SPECIFIED HEREIN. SUBMITTAL OF ANY CONTRARY TERMS AND CONDITIONS MAY CAUSE YOUR BID TO BE REJECTED. BY SIGNING AND SUBMITTING A BID, VENDOR AGREES THAT CONTRARY TERMS AND CONDITIONS WHICH MAY BE INCLUDED IN ITS BID ARE NULLIFIED AND AGREES THAT THIS CONTRACT SHALL BE CONSTRUED IN ACCORDANCE WITH THIS SOLICITATION.**

**34. VENDORS FORMS:**

THE PURCHASE/RELEASE ORDER IS THE ONLY BINDING DOCUMENT TO BE ALLOWED AGAINST THIS CONTRACT. SIGNING OF VENDOR'S FORMS IS NOT ALLOWED.

# Invitation to Bid

STANDARD TERMS & CONDITIONS

Page 8 of 10

NUMBER : 002795  
OPEN DATE : 06/04/2024 TIME: 02:00 PM

BIDDER:

35. PUBLICIZING AWARDS:

IN ACCORDANCE WITH L.A.C 34:I.535, UNSUCCESSFUL BIDDERS WILL BE NOTIFIED OF THE AWARD PROVIDED THEY SUBMIT WITH THEIR BID A SELF-ADDRESSED STAMPED ENVELOPE REQUESTING THIS INFORMATION.

36. PREFERENCE:

IN ACCORDANCE WITH LOUISIANA REVISED STATUTES 39:1595, A PREFERENCE MAY BE ALLOWED FOR PRODUCTS MANUFACTURED, PRODUCED, GROWN, OR ASSEMBLED IN LOUISIANA OF EQUAL QUALITY. DO YOU CLAIM THIS PREFERENCE?

YES \_\_\_\_\_

SPECIFY THE LINE NUMBER (S) \_\_\_\_\_

SPECIFY LOCATION WITHIN LOUISIANA WHERE THIS PRODUCT IS MANUFACTURED, PRODUCED, GROWN OR ASSEMBLED \_\_\_\_\_

(NOTE: IF MORE SPACE IS REQUIRED, INCLUDE ON SEPARATE SHEET.)

DO YOU HAVE A LOUISIANA BUSINESS WORK FORCE? YES \_\_\_\_\_ NO \_\_\_\_\_

IF SO, DO YOU CERTIFY THAT AT LEAST FIFTY PERCENT (50%) OF YOUR LOUISIANA WORKFORCE IS COMPRISED OF LOUISIANA RESIDENTS?

YES \_\_\_\_\_ NO \_\_\_\_\_

FAILURE TO SPECIFY ABOVE INFORMATION MAY CAUSE ELIMINATION FROM PREFERENCES.

PREFERENCES SHALL NOT APPLY TO SERVICE CONTRACTS.

37. AUDIT OF RECORDS: THE STATE LEGISLATIVE AUDITOR, FEDERAL AUDITORS, AND INTERNAL AUDITORS OF THE STATE SHALL HAVE THE RIGHT TO INSPECT AND AUDIT ALL TIMEKEEPING AND EXPENSE RECORDS OF THE CONTRACTING ENTITY OR ANY SUBCONTRACTOR OF THE CONTRACTING ENTITY TO SUBSTANTIATE AMOUNTS INVOICED BY SUPPLIER WITH RESPECT TO THIS AGREEMENT. THE RIGHTS OF INSPECTION AND AUDIT SHALL COMMENCE AS OF THE DATE OF THIS AGREEMENT AND SHALL CONTINUE FOR A PERIOD OF FIVE (5) YEARS AFTER PROJECT ACCEPTANCE OR AS REQUIRED BY APPLICABLE STATE AND FEDERAL LAW. THE CONTRACTING ENTITY AND ANY SUBCONTRACTOR OF THE CONTRACTING ENTITY SHALL MAINTAIN ALL TIMEKEEPING AND EXPENSE RECORDS RELATED TO THIS AGREEMENT FOR THE ENUMERATED FIVE (5) YEAR PERIOD.

38. CONFIDENTIALITY: CONTRACTOR SHALL PROTECT FROM UNAUTHORIZED USE AND DISCLOSURE ALL INFORMATION RELATING TO THE STATE'S OPERATIONS AND DATA (E.G. FINANCIAL, STATISTICAL, PERSONAL, TECHNICAL, ETC.) THAT BECOMES AVAILABLE TO THE CONTRACTOR IN CARRYING OUT THIS CONTRACT. CONTRACTOR SHALL USE PROTECTING MEASURES THAT ARE THE SAME OR MORE EFFECTIVE THAN THOSE USED BY THE STATE. CONTRACTOR IS NOT REQUIRED TO PROTECT INFORMATION OR DATA THAT IS PUBLICLY AVAILABLE OUTSIDE THE SCOPE OF THIS CONTRACT; ALREADY RIGHTFULLY IN THE CONTRACTOR'S POSSESSION; INDEPENDENTLY DEVELOPED BY THE CONTRACTOR OUTSIDE THE SCOPE OF THIS CONTRACT; OR RIGHTFULLY OBTAINED FROM THIRD PARTIES.

39. CYBERSECURITY TRAINING: IN ACCORDANCE WITH LA. R.S. 42:1267(B) (3) AND THE STATE OF LOUISIANA'S INFORMATION SECURITY POLICY, IF THE CONTRACTOR, ANY OF ITS EMPLOYEES, AGENTS, OR SUBCONTRACTORS WILL HAVE ACCESS TO STATE GOVERNMENT INFORMATION TECHNOLOGY ASSETS, THE CONTRACTOR'S EMPLOYEES, AGENTS, OR SUBCONTRACTORS WITH SUCH ACCESS MUST COMPLETE CYBERSECURITY TRAINING ANNUALLY, AND THE CONTRACTOR MUST PRESENT EVIDENCE OF SUCH COMPLIANCE ANNUALLY AND UPON REQUEST. THE CONTRACTOR MAY USE THE CYBERSECURITY TRAINING COURSE OFFERED BY THE LOUISIANA DEPARTMENT OF STATE CIVIL SERVICE WITHOUT ADDITIONAL COST OR MAY USE ANY ALTERNATE COURSE APPROVED IN WRITING BY THE OFFICE OF TECHNOLOGY SERVICES.

# Invitation to Bid

<b>STANDARD TERMS &amp; CONDITIONS</b>	Page 9 of 10
<b>NUMBER : 002795</b> <b>OPEN DATE : 06/04/2024</b> <b>TIME: 02:00 PM</b>	<b>BIDDER:</b>
<p>FOR PURPOSES OF THIS SECTION, "ACCESS TO STATE GOVERNMENT INFORMATION TECHNOLOGY ASSETS" MEANS THE POSSESSION OF CREDENTIALS, EQUIPMENT, OR AUTHORIZATION TO ACCESS THE INTERNAL WORKINGS OF STATE INFORMATION TECHNOLOGY SYSTEMS OR NETWORKS. EXAMPLES WOULD INCLUDE BUT NOT BE LIMITED TO STATE-ISSUED LAPTOPS, VPN CREDENTIALS TO ACCESS THE STATE NETWORK, BADGING TO ACCESS THE STATE'S TELECOMMUNICATIONS CLOSETS OR SYSTEMS, OR PERMISSIONS TO MAINTAIN OR MODIFY IT SYSTEMS USED BY THE STATE. FINAL DETERMINATION OF SCOPE INCLUSIONS OR EXCLUSIONS RELATIVE TO ACCESS TO STATE GOVERNMENT INFORMATION TECHNOLOGY ASSETS WILL BE MADE BY THE OFFICE OF TECHNOLOGY SERVICES.</p>	

# Invitation to Bid

<b>PRICE SHEET</b>		Page 10 of 10		
<b>NUMBER : 002795</b> <b>OPEN DATE : 06/04/2024      TIME: 02:00 PM</b>		<b>BIDDER:</b>		
UNLESS SPECIFIED ELSEWHERE SHIP TO:				
<i>Total From Specifications Price Sheet</i>				
Line No.	Description			\$
1	<p>Versteel Brand Furniture as specified in the attached specifications.</p> <hr style="width: 30%; margin-left: 0;"/> <p>The LSU Health Sciences Center in New Orleans (LSUHSC) requests quotes for Versteel Brand Furniture as specified in the attached specifications. This is an All or None bid. This bid is brand specific based on LSUHSC standards. Substitutions are not allowed. Pricing is to include freight (FOB Destination), inside delivery, assembly, set in place, and removal of packing materials and trash to the following location: LSUHSC Human Development Center 411 S. Prieur St. New Orleans, LA 70112 Coordinate delivery with LSUHSC personnel (Rachelle Falcon 504-568-2834) prior to shipment. This is an All or None bid. The total bid sum will be used to determine the lowest responsive and qualified bidder. Bids are due Tuesday, June 4, 2024 at 2:00 PM. Submit bids to the attention of: Michael Williams LSUHSC Purchasing Department 433 Bolivar St. Room 623 New Orleans, LA 70112 504-568-6261 phone</p>			

# SPECIFICATIONS PRICE SHEET

## LSUHSC HUMAN DEVELOPMENT CENTER - STUDY ROOMS

VERTSEEL BID DOCUMENTS  
PER UNIVERSITY STANDARDS

### SPECIFICATIONS

			SELL	EXT. SELL
<b>01</b>				
<b>9</b>	<b>SPECIAL VELA</b>	<b>Vela Y3, 48 x 60 Rectangle Fixed</b>		
		<b>L</b> HP Laminate Surface Table Top		
		<b>P2S</b> 1 1/4" Flat PVC w/Square Corners		
		<b>TW</b> Wilsonart		
		<b>TWSPEC</b> Special Wilsonart Laminate		
		<b>TOR</b> WILSONART PALACE YO838-60		
		<b>TBD</b> Std PVC Edge (to be specified)		
		> Standard Process		
		<b>TBD</b> Std Powder Coat (to be specified)		
		~ Standard 29" Tbl Height		
<b>02</b>				
<b>36</b>	<b>CLFL-01</b>	<b>Companion Flare, w/o Arms, Uph Seat &amp; Back</b>		
		> Standard Process		
		<b>PCHA</b> Champagne (Frame)		
		<b>TOR</b> ARCCOM MOON BEAM 2, ac60584 STONE 2		



~ Standard Glides

1 FREIGHT

DELIVERY AND INSTALLATION PER DRAWING.  
HAUL ALL TRASH AWAY.

GRAND TOTAL

**ROOM CONFIGURATION**

- (3) 48" X 60" VELA TABLES
- 1-1/4" FLAT PVC EDGE W/ SQUARE CORNERS
- (2) VELA VY34 FIXED BASES W/ GLIDES
- (12) CLFL-01 COMPANION CHAIRS

**GLIDES**



**REVISIONS**

REV	REV DATE	DESCRIPTION	ECH NUMBER	REVISION BY

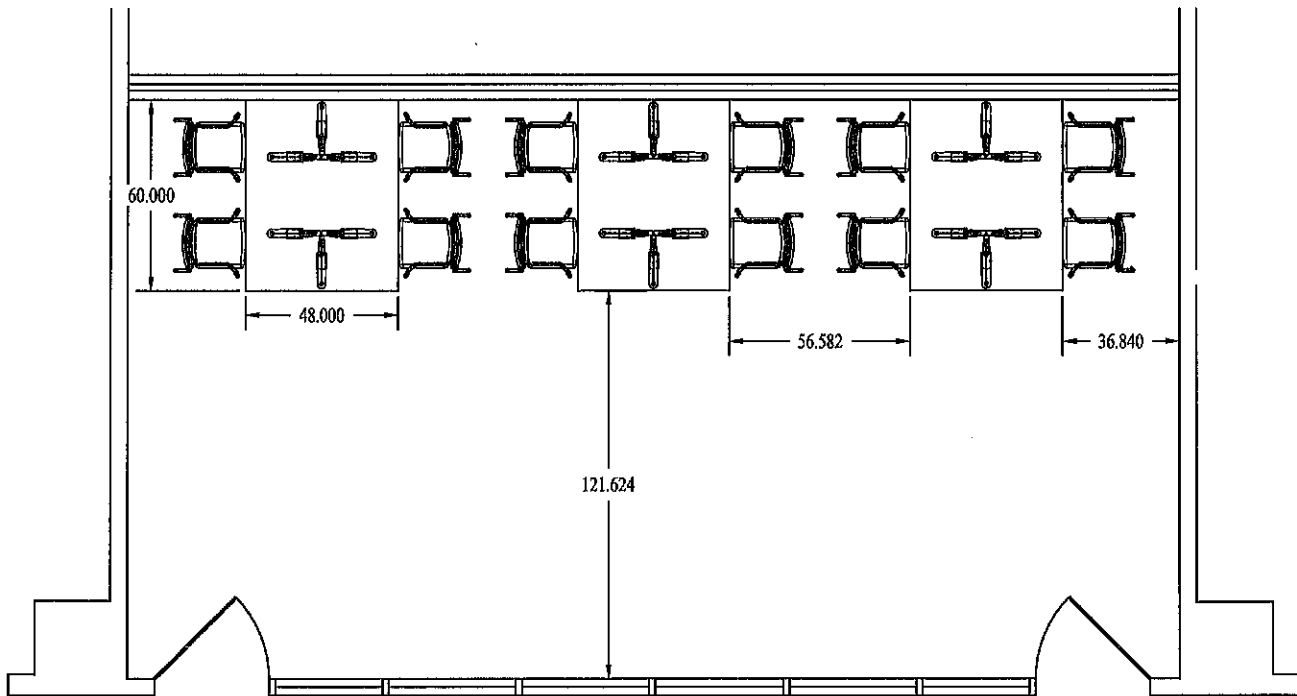

SPECIAL COSTING: See Engineering Request Form

**VERSTEEL**

ITEM DESCRIPTION: LAYOUT			REV.
DATE: 5/10/2024	AUTHOR: A. Owens	APPROVER:	SCALE: NTS
ITEM CLASS: MFGASM	DWG TYPE: LAYOUT	SHEET 1 OF 1	
MAT'L:	DWG NO.		L26994-1 Room
FINISH:			

LP2R/S

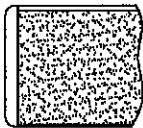

UNLESS OTHERWISE SPECIFIED  
DIMENSIONS ARE IN INCHES  
TOLERANCES

- 2 PLACE DECIMAL ±.030
- 3 PLACE DECIMAL ±.015
- 4 PLACE DECIMAL ±.005
- ANGULAR ± 0.5°

DO NOT SCALE DRAWING

INTERPRETATION OF THIS DRAWING  
PER ANSI DRAFTING MANUAL Y14.5M

TOP VIEW  
TOP DEPICTED AS TRANSPARENT FOR CLARITY

DWG NO. L26994-1 Room

48" X 60" RECTANGLE  
 1-1/4" FLAT PVC EDGE W/ SQUARE CORNERS  
 (2) VELA VY34 FIXED BASES W/ GLIDES

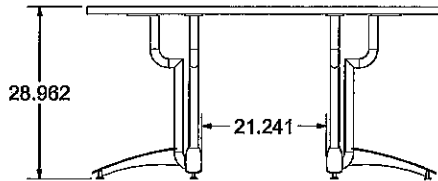
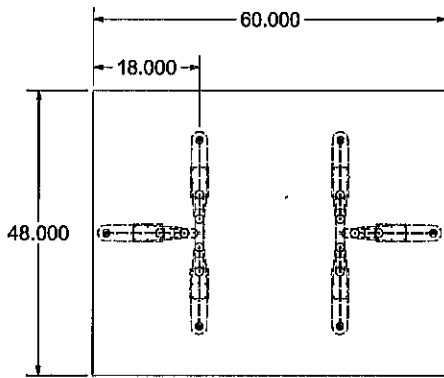

REVISIONS				
REV.	DESCRIPTION	DATE	EDW NO.	BY

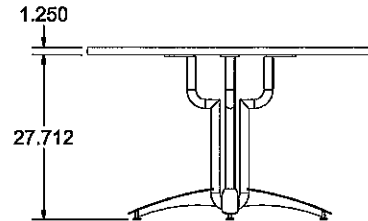
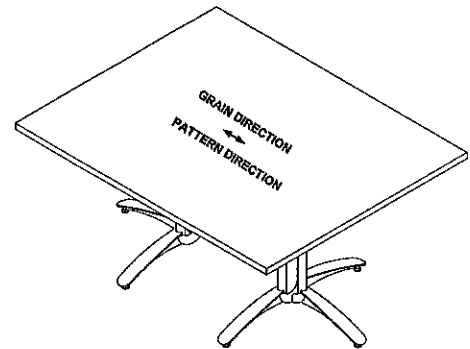

SPECIAL LEAD TIME:

SPECIAL COSTING: SEE ENGINEERING REQUEST FORM

UNLESS OTHERWISE SPECIFIED  
 DIMENSIONS ARE IN INCHES  
 TOLERANCES

2 PLACE DECIMAL ±.030  
 3 PLACE DECIMAL ±.015  
 4 PLACE DECIMAL ±.005  
 ANGULAR ±0.5°

DO NOT SCALE DRAWING

INTERPRETATION OF THIS DRAWING  
 PER ANSI DRAFTING MANUAL Y14.5M

		REV.	
		ITEM DESCRIPTION LAYOUT	
DATE: 5/13/2024	AUTHOR: A. Owens	APPROVER:	SCALE: NTS
ITEM CLASS: MFGASM	DWG. TYPE: LAYOUT	SHEET 1 OF 1	
MATERIAL:	DWG. NO.		L26994-1
FINISH:			

DWG. NO.

L26994-1

**ATTACHMENT A: CERTIFICATION STATEMENT**

**OFFICIAL CONTACT.** The State requires that the Provider designate one person to receive all documents and the method in which the documents are best delivered. Identify the Contact name and fill in the information below: (Print Clearly):

Date: \_\_\_\_\_ Official Contact Name: \_\_\_\_\_

A. E-mail Address: \_\_\_\_\_

B. Facsimile Number with area code: (\_\_\_\_) \_\_\_\_\_

C. US Mail Address: \_\_\_\_\_

D. Telephone Number: \_\_\_\_\_

Provider certifies that the above information is true and grants permission to the State or Agencies to contact the above named person or otherwise verify the information I have provided.

By its submission of this proposal and authorized signature below, Provider certifies that:

- (1) The information contained in its response to this RFQ is accurate;
- (2) Provider warrants that, to the best of his/her/its knowledge and belief, there are no relevant facts which could give rise to organizational conflicts of interest or that the Provider has disclosed all potential or actual organizational conflicts of interest. The Provider agrees that if it becomes the Selected Provider and an organizational conflict of interest with respect to this contract is then discovered, an immediate and full disclosure in writing shall be made to the LSUHSC-NO which shall include a description of the action which the Provider has taken or will take to avoid or mitigate such conflicts. In the event that the successful Provider knowingly failed to disclose a conflict, LSUHSC-NO may immediately terminate the contract for default. Provider certifies that its personnel, who perform work under this contract, have been informed of their obligations to report personal and organizational conflicts of interest to the Provider. The term of this prohibition shall endure for the entire period of this contract and for two (2) years thereafter.
- (3) Provider complies with each of the mandatory requirements listed in the RFQ and will meet or exceed the deliverables specified therein;
- (4) Provider accepts the procedures, contract terms and conditions, and all other administrative requirements set forth in this RFQ.
- (5) Provider's quote is valid for at least thirty (30) days from the date of Provider's signature below;
- (6) Proposer certifies and agrees that the following information is correct: In preparing its response, the Proposer has considered all proposals submitted from qualified, potential subcontractors and suppliers, and has not, in the solicitation, selection, or commercial treatment of any subcontractor or supplier, refused to transact or terminated business activities, or taken other actions intended to limit commercial relations, with a person or entity that is engaging in commercial transactions in Israel or Israeli-controlled territories, with the specific intent to accomplish a boycott or divestment of Israel. Proposer also has not retaliated against any person or other entity for reporting such refusal, termination, or commercially limiting actions. The State reserves the right to reject the response of the proposer if this certification is subsequently determined to be false, and to terminate any contract awarded based on such a false response.

Authorized Signature: \_\_\_\_\_

Typed or Printed Name: \_\_\_\_\_

Title: \_\_\_\_\_

Company Name: \_\_\_\_\_

Address: \_\_\_\_\_

City: \_\_\_\_\_ State: \_\_\_\_\_ Zip: \_\_\_\_\_

\_\_\_\_\_  
SIGNATURE of Provider's Authorized Representative

\_\_\_\_\_  
DATE

**ATTACHMENT B - INDEMNIFICATION AGREEMENT**

The Selected Provider/Subsupplier agrees to protect, defend, indemnify, save, and hold harmless LSUHSC-NO, State of Louisiana, all State Departments, Boards, and Commissions, officers, agents, servants, and employees, including volunteers, from and against any and all claims, demands, expense, and liability arising out of injury or death to any person or the damage, loss or destruction of any property which may occur or in any way grow out of any act or omission of Selected Provider/Subsupplier, its agents, servants, and employees or any and all costs, expense, and/or attorney fees incurred by Selected Provider/Subsupplier, as a result of any claims, demands, and/or causes of action except of those claims, demands, and/or causes of action arising out of the negligence of LSUHSC-NO, State of Louisiana, all State Departments, Boards, Commissions, its agents, representatives, and/or employees. Selected Provider/ Subsupplier agrees to investigate, handle, respond to, provide defense for and defend any such claim, demand, or suit at its sole expense and agrees to bear all other costs and expenses related thereto, even if any such claim, demand, or suit is groundless, false, or fraudulent.

LSUHSC-NO shall not be responsible or held liable for any injury or damage to persons or property resulting from the use, misuse, or failure of any equipment used by the Selected Provider or any of the Selected Provider's agents, servants, or employees, even if such equipment is furnished by LSUHSC-NO to the Selected Provider. The acceptance or use of any such equipment by the Selected Provider shall be construed to mean that the Selected Provider accepts full responsibility for, and agrees to indemnify and to defend LSUHSC-NO against any and all loss, liability, and claims for any injury or damage whatsoever resulting from the use, misuse, or failure of such equipment, whether such damage or injury is to an employee, agent, or servant, or the property of the Selected Provider, other suppliers or subsuppliers, LSUHSC-NO, or other persons.

Accepted by: Company \_\_\_\_\_  
Name \_\_\_\_\_  
Signature \_\_\_\_\_  
Title \_\_\_\_\_  
Date \_\_\_\_\_

Is Certificate of Insurance Attached? \_\_\_\_\_ Yes \_\_\_\_\_ No

## **ATTACHMENT C: EQUAL EMPLOYMENT OPPORTUNITY CLAUSE**

As required by U.S. Labor Department, Office of Federal Contract Compliance, Section 60-1.4.

During the performance of this contract, the successful bidder (supplier or vendor) agrees as follows:

- (1)The Supplier will not discriminate against any employee or applicant for employment because of race, color, religion, sex, or national origin. The Supplier will take affirmative action to ensure that applicants are employed, and that employees are treated during employment, without regard to their race, color, religion, sex, or national origin. Such action shall include, but not be limited to the following: Employment, upgrading, demotion, or transfer, recruitment advertising, layoff or termination, rates of pay or other forms of compensation, and selection for training, including apprenticeship. The Supplier agrees to post in conspicuous places, available to employees and applicants for employment, notices to be provided by the contracting offer setting forth the provision of this non-discrimination clause.
- (2)The Supplier will, in all solicitations or advertisements for employees placed by or on behalf of the Supplier, state that all qualified applicants will receive consideration for employment without regard to race, color, religion, sex or national origin.
- (3)The Supplier will send to each labor union or representative of workers with which he has a collective bargaining agreement or other contract or understanding, a notice to be provided by the agency contracting officer, advising the labor union or workers' representative of the Supplier's commitments under section 202 of Executive Order 11246 of September 24, 1965, and shall post copies of the notice in conspicuous places available to employees and applicants for employment.
- (4)The Supplier will comply with all provisions of Executive Order 11246 of September 24, 1965, and of the rules, regulations, and relevant orders of the Secretary of Labor.
- (5)The Supplier will furnish all information and reports required by Executive Order 11246 of September 24, 1965, and by the rules, regulations, and orders of the Secretary of Labor, or pursuant thereto, and will permit access of his books, records, and accounts by the contracting agency and the Secretary of Labor for purposes of investigation to ascertain compliance with such rules, regulations, and orders.
- (6)In the event of the Supplier's noncompliance with the non-discrimination clauses of this contract or with any of such rules, regulations, or orders, this contract may be canceled, terminated or suspended in whole or in part and the Supplier may be declared ineligible for further Government contracts in accordance with procedures authorized in Executive Order 11246 of September 24, 1965, and such other sanctions may be imposed and remedies invoked as provided in Executive Order 11246 of September 24, 1965, or by rule, regulation, or order of the Secretary of Labor, or as otherwise provided by law.
- (7)The Supplier will include the provisions of paragraphs (1) through (7) in every subcontract or purchase order unless exempted by rules, regulations, or orders of the Secretary of Labor issued pursuant to section 204 of Executive Order 11246 of September 24, 1965, so that such provisions will be binding upon each subsupplier or vendor. The Supplier will take such action with respect to any subcontract or purchase order as the contracting agency may use direct as a means of enforcing such provisions including sanctions for noncompliance: Provided, however, that in the event the Supplier becomes involved in, or is threatened with, litigation with the subsupplier or vendor as a result of such direction by the contracting agency, the Supplier may request the United States to enter into such litigation to protect the interests of the United States.

## Assurance

The bidder (offeror or applicant) assures Board of Supervisors of Louisiana State University and Agricultural and Mechanical College that he does not and will not maintain or provide for his employees any segregated facilities at any of his establishments, and that he does not and will not permit his employees to perform their services at any location, under his control, where segregated facilities are maintained. The bidder (offeror or applicant) understands that the phrase "segregated facilities" includes facilities which are in fact segregated on a basis of race, color, creed, or national origin, because of habit, local custom, or otherwise. The bidder (offeror or applicant) understands and agrees that maintaining or providing segregated facilities for his employees or permitting his employees to perform their services at any locations, under his control, where segregated facilities are maintained is a violation of the equal opportunity clause required by Executive Order 11246 of September 24, 1965.

The bidder (offeror or applicant) further understands and agrees that a breach of the assurance herein contained subjects him to the provisions of Orders of the Secretary of Labor dated May 9, 1967, and the provisions of Orders of the Secretary of Labor dated May 9, 1967, and the provisions of equal opportunity clause enumerated in contract between Board of Supervisors of Louisiana State University and Agricultural and Mechanical College and bidder (offeror or applicant).

Whoever knowingly and willfully makes any false, fictitious, or fraudulent representation may be liable to criminal prosecution under 18 U.S.C. Section 1001.

Vendor

By:

Name and Title

(must be signed by an authorized Executive Official)

Date:

## **ATTACHMENT D: AFFIRMATIVE ACTION COMPLIANCE**

(a) **REQUIREMENTS OF PROGRAMS.** In accordance with Section 60-1.4 of Chapter 60 of Title 41 of the Code of Federal Regulations, as amended, the Seller shall develop and shall require each of its lower-tier subsuppliers hereunder who has 50 or more employees and a subcontract of \$50,000 or more to develop a written affirmative action compliance program for each of its establishments. A necessary prerequisite to the development of a satisfactory affirmative action program is the identification and analysis of problem areas inherent in minority employment and an evaluation of opportunities of utilization of minority group personnel. The Seller's and each of its nonexempt lower-tier subsupplier's programs shall provide in detail for specific steps to guarantee equal employment opportunity keyed to the problems and needs of members of minority groups, including, when there are deficiencies, the development of specific goals and timetables for the prompt achievement of full and equal employment opportunity. The Seller and each of its nonexempt lower-tier subsuppliers shall include in his affirmative action compliance program a table of job classifications. This table should include but not be limited to job titles, principal duties (and auxiliary duties if any), rates of pay, and where more than one rate of pay applies (because of length of time in job or other factors), the applicable rates. The affirmative action compliance program shall be signed by an executive official of the Seller or lower-tier subsupplier as the case may be.

(b) **UTILIZATION EVALUATION.** The evaluation of utilization of minority group personnel shall include the following:

- (1) An analysis of minority group representation in all job categories.
- (2) An analysis of hiring practices for the past year, including recruitment sources and testing, to determine whether equal employment opportunity is being afforded in all job categories.
- (3) An analysis of upgrading, transfer and promotion for the past year to determine whether equal employment opportunity is being afforded.

(c) **MAINTENANCE OF PROGRAMS.** Within 120 days from the commencement of the applicable purchase order of the lower-tier subcontract hereunder, the Seller and each nonexempt lower-tier subcontract hereunder shall maintain a copy of separate affirmative action compliance programs for each establishment, including evaluations of utilization of minority group personnel and the job classification tables, at each local office responsible for the personnel matters of such establishment. An affirmative action compliance program shall be part of the manpower and training plans for each new establishment and shall be developed and made available prior to the staffing of such establishment. A report of the results of such program shall be compiled annually and the program shall be updated at that time. This information shall be made available to representative of the agency or director upon request and the Seller's and each nonexempt lower-tier subsupplier's affirmative action program and the results it produces shall be evaluated as part of compliance review activities.

VENDOR:

BY:

(Must be signed by authorized executive official)

TITLE:

DATE:



# ATTACHMENT E – INSURANCE REQUIREMENTS

## INSURANCE REQUIREMENTS FOR SUPPLIERS

Supplier shall procure and maintain for the duration of the contract insurance against claims for injuries to persons or damages to property which may arise from or in connection with the performance of the work hereunder by the Supplier, his agents, representatives, employees, or subsuppliers.

### A. MINIMUM SCOPE OF INSURANCE

Coverage shall be at least as broad as:

1. Insurance Services Office form number GL 002 (Ed. 1/73) covering Comprehensive General Liability and Insurance Services Office form number GL 0404 covering Broad Form Comprehensive General Liability; or Insurance Services Office Commercial General Liability coverage (occurrence form CG 0001). **“Claims Made” form is unacceptable. The “occurrence form” shall not have a “sunset clause”.**
2. Insurance Services Office form number CA 0001 (Ed. 1/78) covering Automobile Liability, code 1 “any auto” and endorsement CA 0025.
3. Workers’ Compensation Insurance as required by the Labor Code of the State of Louisiana, including Employers Liability insurance.

### B. MINIMUM LIMITS OF INSURANCE

Supplier shall maintain limits no less than:

1. Commercial General Liability: \$1,000,000 combined single limit per occurrence for bodily injury, personal injury and property damage (or higher limits depending on size of contract).
2. Automobile Liability: \$1,000,000 combined single limit per accident, for bodily injury and property damage.
3. Workers Compensation and Employers Liability: Worker’s Compensation limits as required by the Labor Code of the State of Louisiana and Statutory Employers Liability limits. Exception: Employers liability limit is to be \$1,000,000 when work is to be over water and involves maritime exposure.

### C. DEDUCTIBLES AND SELF-INSURED RETENTIONS

Any deductibles or self-insured retention's must be declared to and approved by the University. At the option of the University, either: the insurer shall reduce or eliminate such deductibles or self-insured retention's as respects the University, its officers, officials, employees and volunteers; or the Supplier shall procure a bond guaranteeing payment of losses and related investigations, claim administration and defense expenses.

**D. OTHER INSURANCE PROVISIONS**

The policies are to contain, or be endorsed to contain, the following provisions:

1. General Liability and Automobile Liability Coverage

- a. The University, its officers, officials, employees, Boards and Commissions and volunteers are to be added as "additional insured" as respects liability arising out of activities performed by or on behalf of the Supplier; products and completed operations of the Supplier, premises owned, occupied, or used by the Supplier. The coverage shall contain no special limitations on the scope of protection afforded to the University, its officers, officials, employees or volunteers. It is understood that the business auto policy under "Who is an Insured" automatically provides liability coverage in favor of the University.
- b. The Supplier's Insurance coverage shall be primary insurance as respects the University, its officers, officials, employees and volunteers. Any insurance or self-insurance maintained by the University, its officers, officials, employees or volunteers shall be excess of the Supplier's insurance and shall not contribute with it.
- c. Any failure to comply with reporting provisions of the policy shall not affect coverage provided to the University, its officers, officials, employees, Boards and Commissions, or volunteers.
- d. The Supplier's insurance shall apply separately to each insured against whom claim is made or suit is brought, except with respect to the limits of the insurer's liability.

2. Worker's Compensation and Employers Liability Coverage

The insurer shall agree to waive all rights of subrogation against the University, its officers, officials, employees and volunteers for losses arising from work performed by the Supplier for the University.

3. All Coverage's

Each insurance policy required by this clause shall be endorsed to state that coverage shall not be suspended, voided, canceled by either party, reduced in coverage or in limits except after thirty (30) days' prior written notice by certified mail, return receipt requested, has been given to the University.

**E. ACCEPTABILITY OF INSURERS**

Insurance is to be placed with insurers with an A.M. Best's rating of no less than A-:VI. This requirement will be waived for workers' compensation coverage only for those suppliers whose workers' compensation coverage is placed with companies who participate in the State of Louisiana Workers' Compensation Assigned Risk Pool.

**F. VERIFICATION OF COVERAGE**

Supplier shall furnish the University with certificates of insurance effecting coverage required. The certificate for each insurance policy is to be signed by a person authorized by that insurer to bind coverage on its behalf. The University reserves the right to require complete, certified copies of all required insurance policies, at any time.

## **ATTACHMENT F – Request For Supplier Diversity Certifications**

Louisiana State University is committed to fostering innovation and entrepreneurship through the use of diverse suppliers and the goal of the diversity initiative is to identify, align, strengthen and connect with diverse suppliers.

If your company holds a small business and or supplier diversity certification(s) please email them to me for inclusion in our supplier database. Examples are listed below.

### **AbilityOne: formerly Javits-Wagner-O'Day or JWOD**

Creates jobs and training opportunities for people who are blind or who have other severe disabilities. Javits-Wagner-O'Day Act of 1971, 41 U.S.C. 46-48c, the AbilityOne Program is a mandatory source of supply for Federal employees

### **Disadvantaged Business Enterprise: DBE**

The US Department of Transportation offers the certification for small socially and economically disadvantaged businesses.

### **Disabled Veteran Owned Small Business: DVOSB**

### **Emerging Business Enterprise: EBE**

### **Lesbian, Gay, Bisexual and Transgender-Owned Business: LGBTBE**

### **Minority-Owned Business Enterprise: MBE**

Certified by LA Minority Supplier Development Council; National Minority Supplier Development Council; other certification entities

### **Small Business Enterprise: SBE**

### **Small Disadvantaged business: SDB**

Certified by the Federal Small Business Association

### **Service- Connected Disabled Veteran-Owned Entrepreneurship: SDVB**

Certified by the Louisiana Economic Development office

### **Small & Emerging Business Development program: SEBD**

Certified by the Louisiana Economic Development office

### **Small Entrepreneurship/ Hudson Initiative: SE**

Certified by the Louisiana Economic Development office

### **Veteran Owned Small Business: VOSB**

### **Veteran Initiative/Veteran Owned Small Entrepreneurship : VSE**

Certified by the Louisiana Economic Development office

### **Woman-Owned Business Enterprise: WBE**

Certified by the Women's Business Enterprise National Council, Women's Business Enterprise Council South; other certification entities